

MATERIAL FOTOCOPIABILE

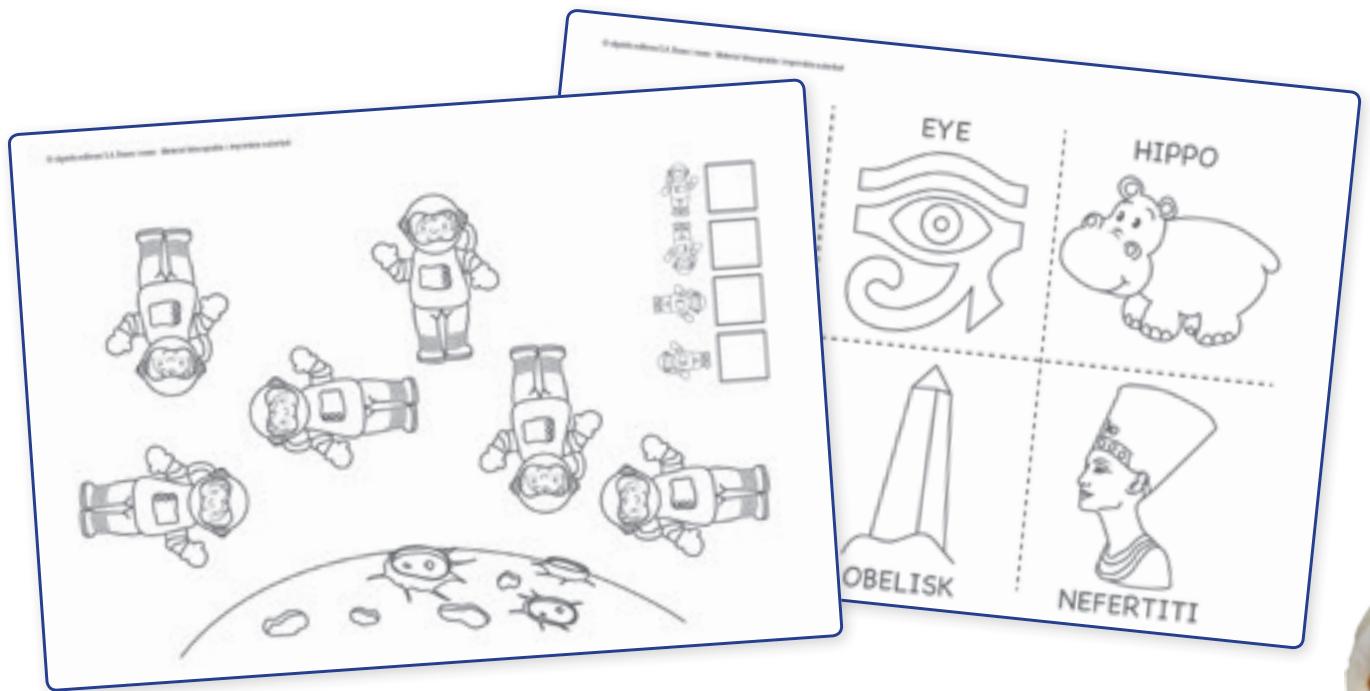

En les fitxes fotocopiables d'aquest llibre no s'inclou cap proposta d'activitat perquè siga cada docent qui propose les que considere oportunes tenint en compte les necessitats de l'alumnat, la seua programació didàctica i la seua realitat educativa. S'hi inclouen paraules i expressions molt senzilles en anglés per a complementar la iniciació en l'aprenentatge d'aquesta llengua.

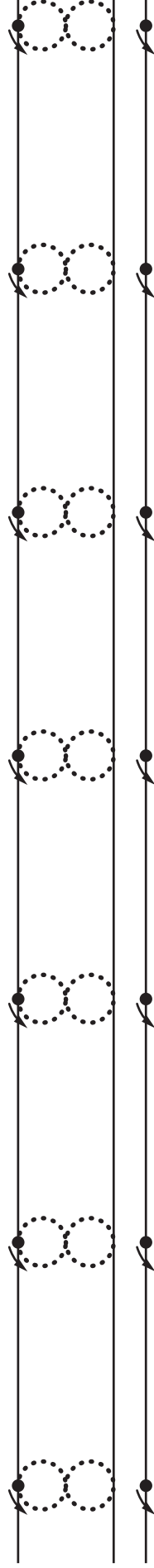

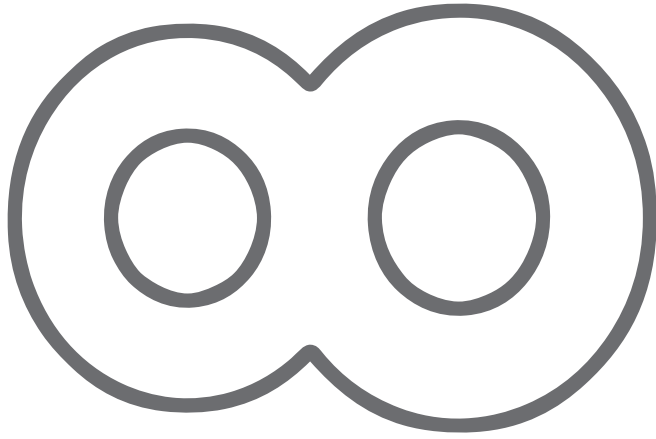
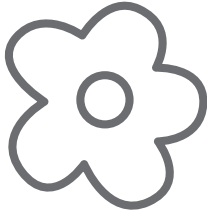
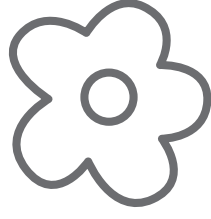

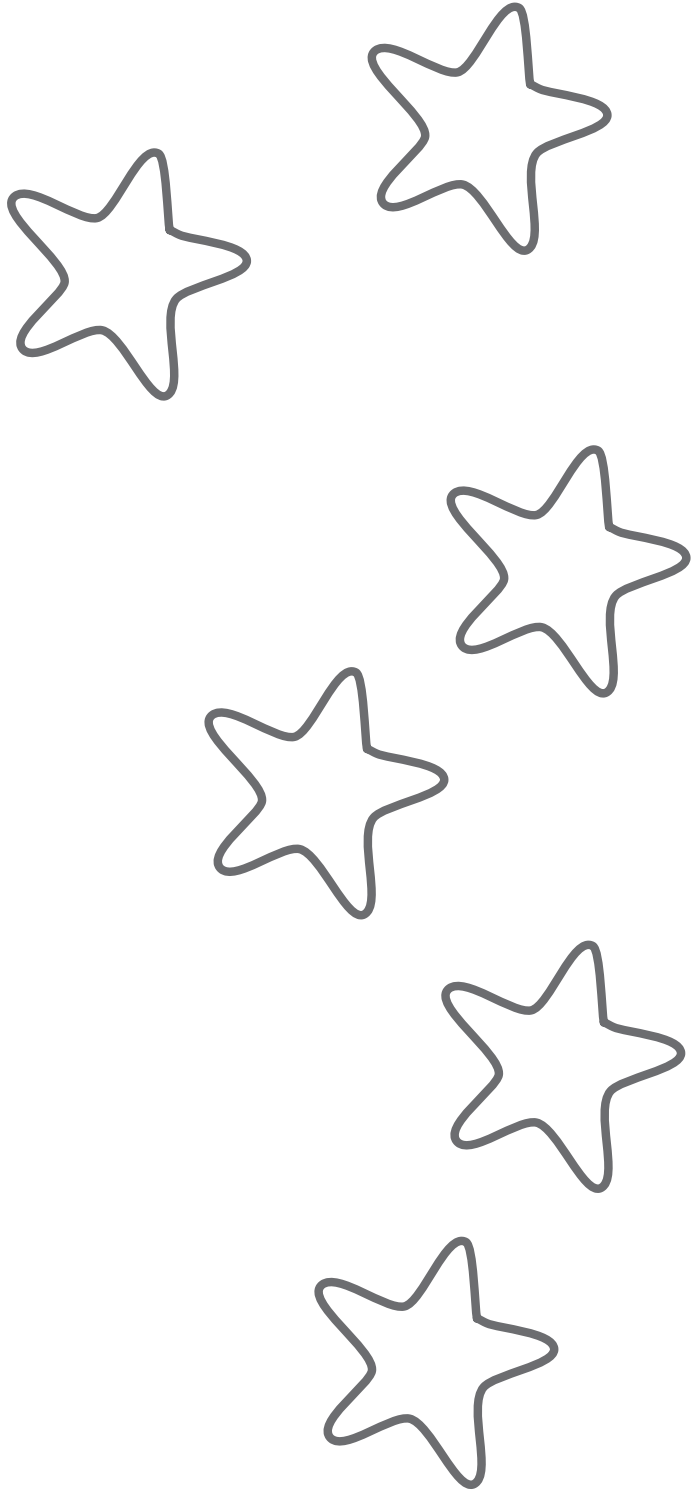
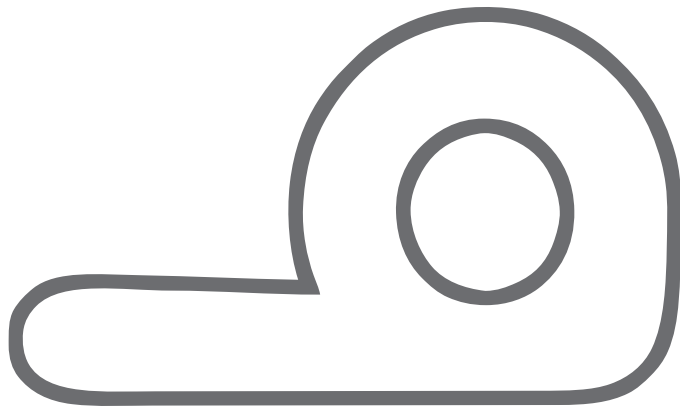
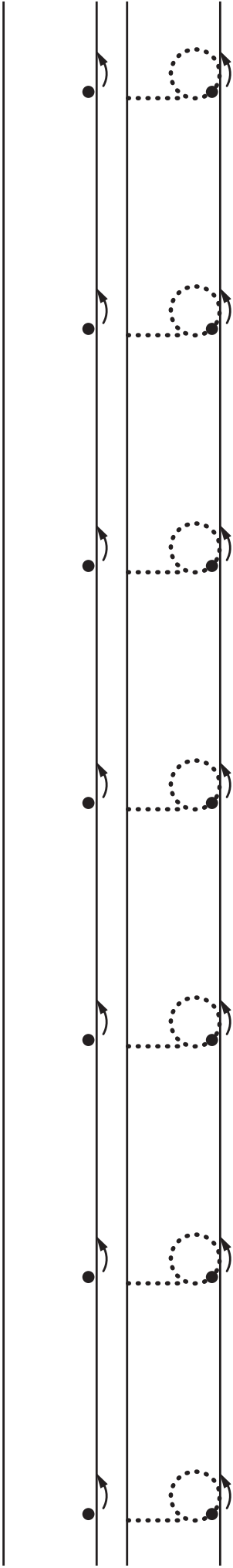

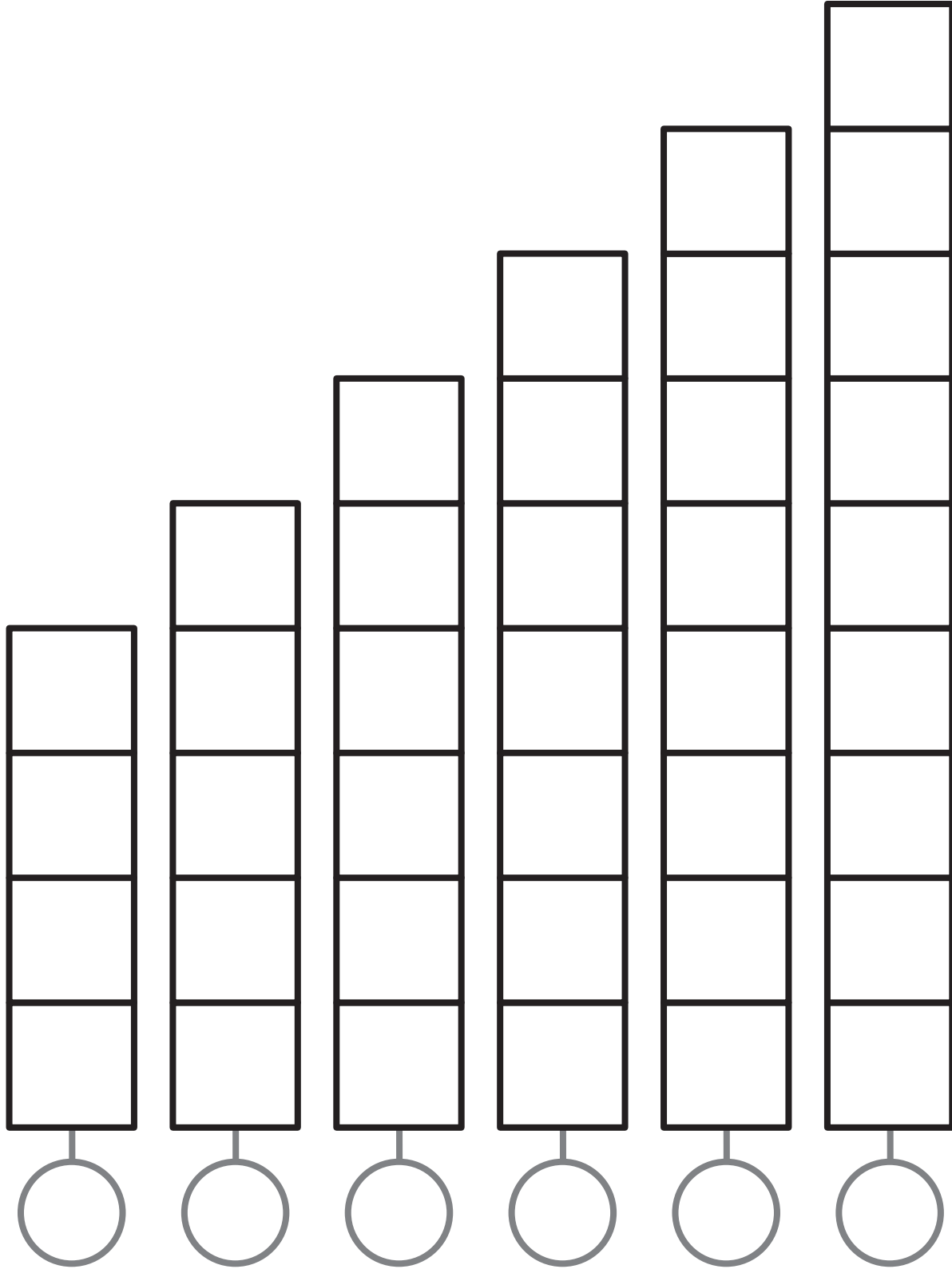

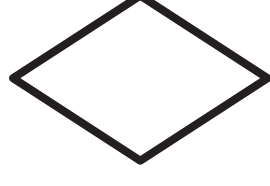
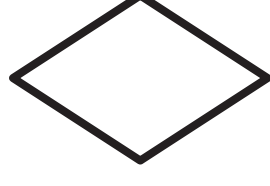
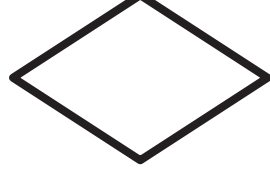
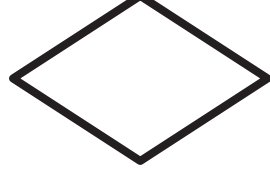
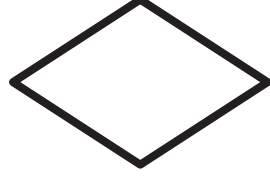
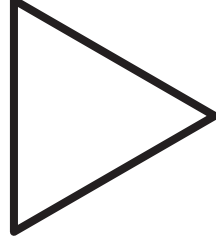
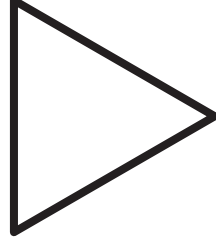
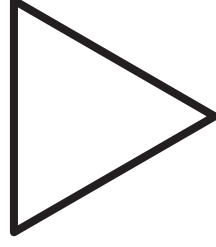
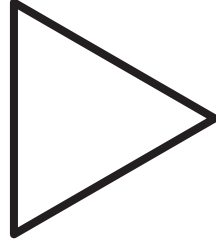
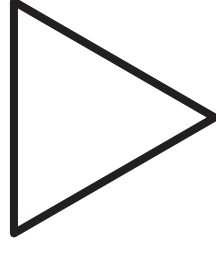
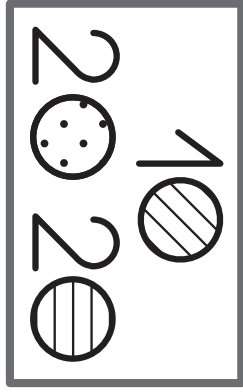
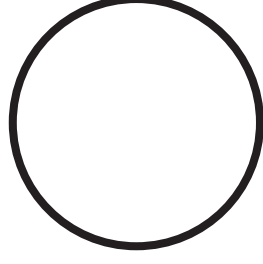
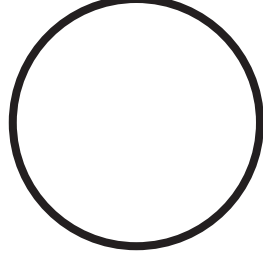
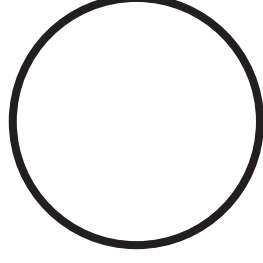
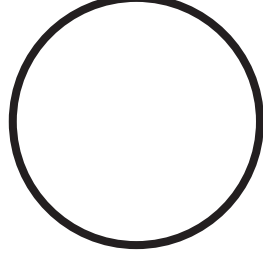
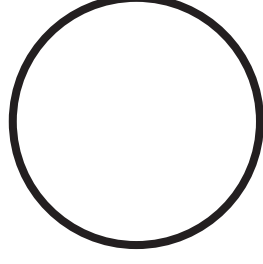
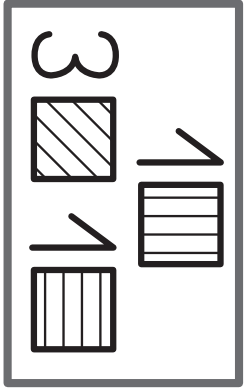
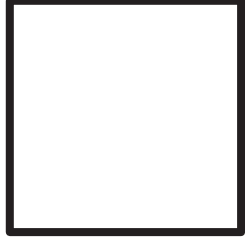
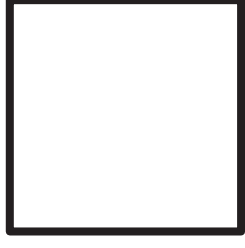
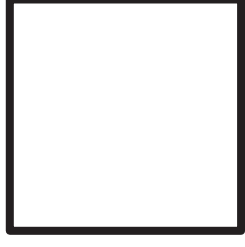
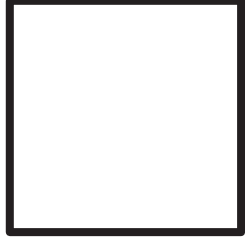
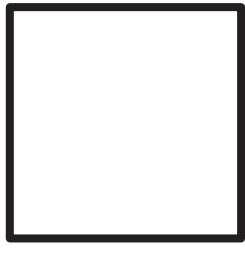

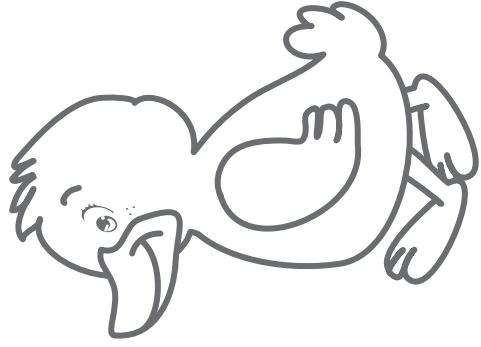
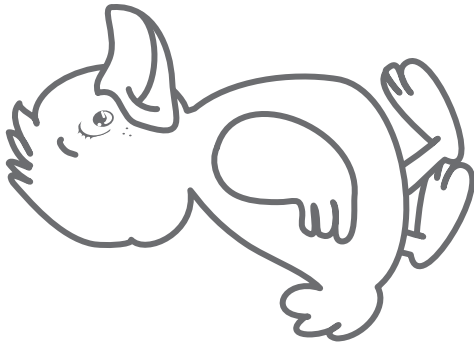
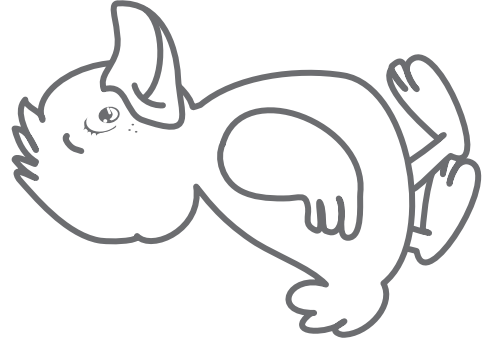
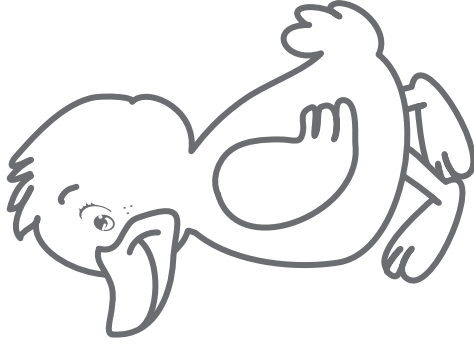
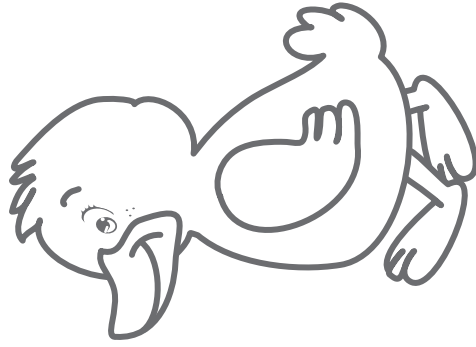
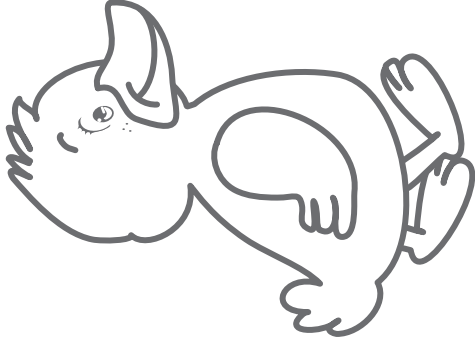
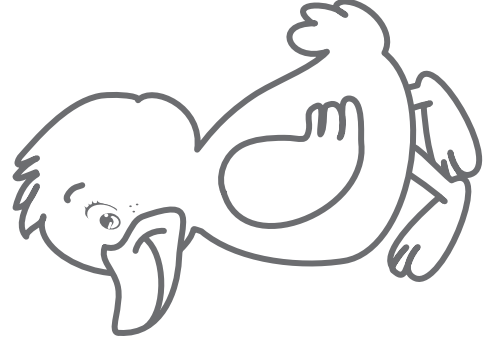
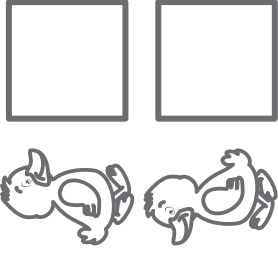

BIG

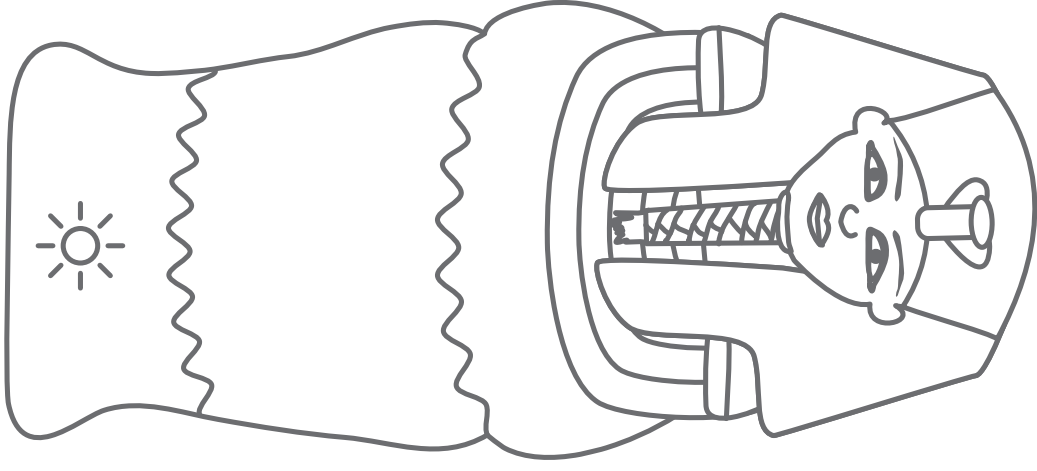

MEDIUM

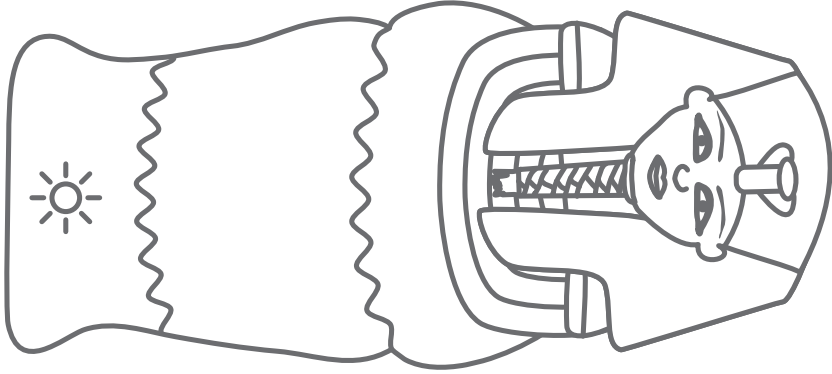

SMALL

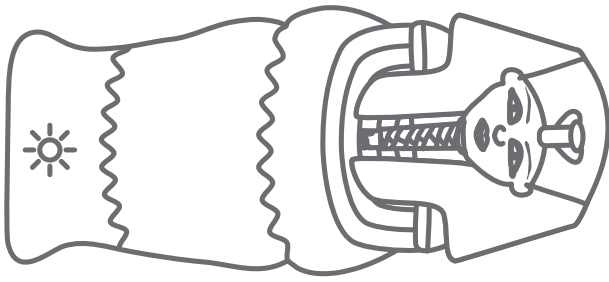

SHAPES!

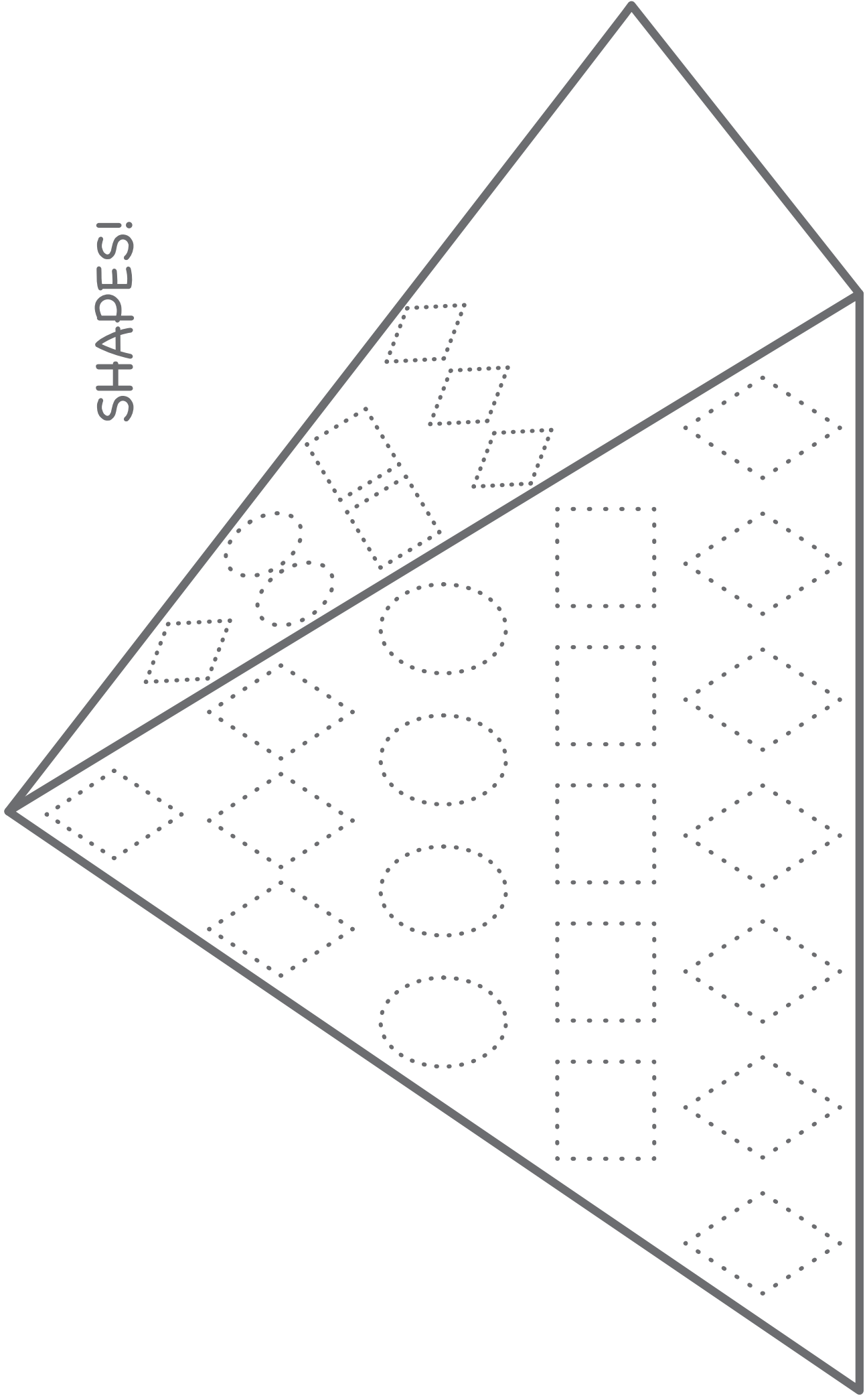

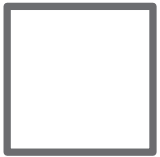

=



+

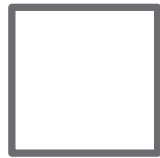

=



+

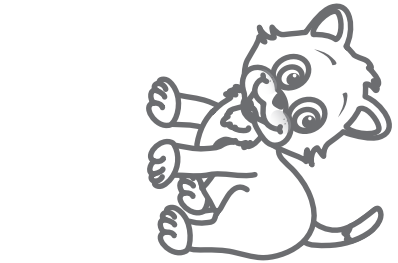
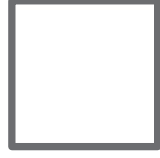

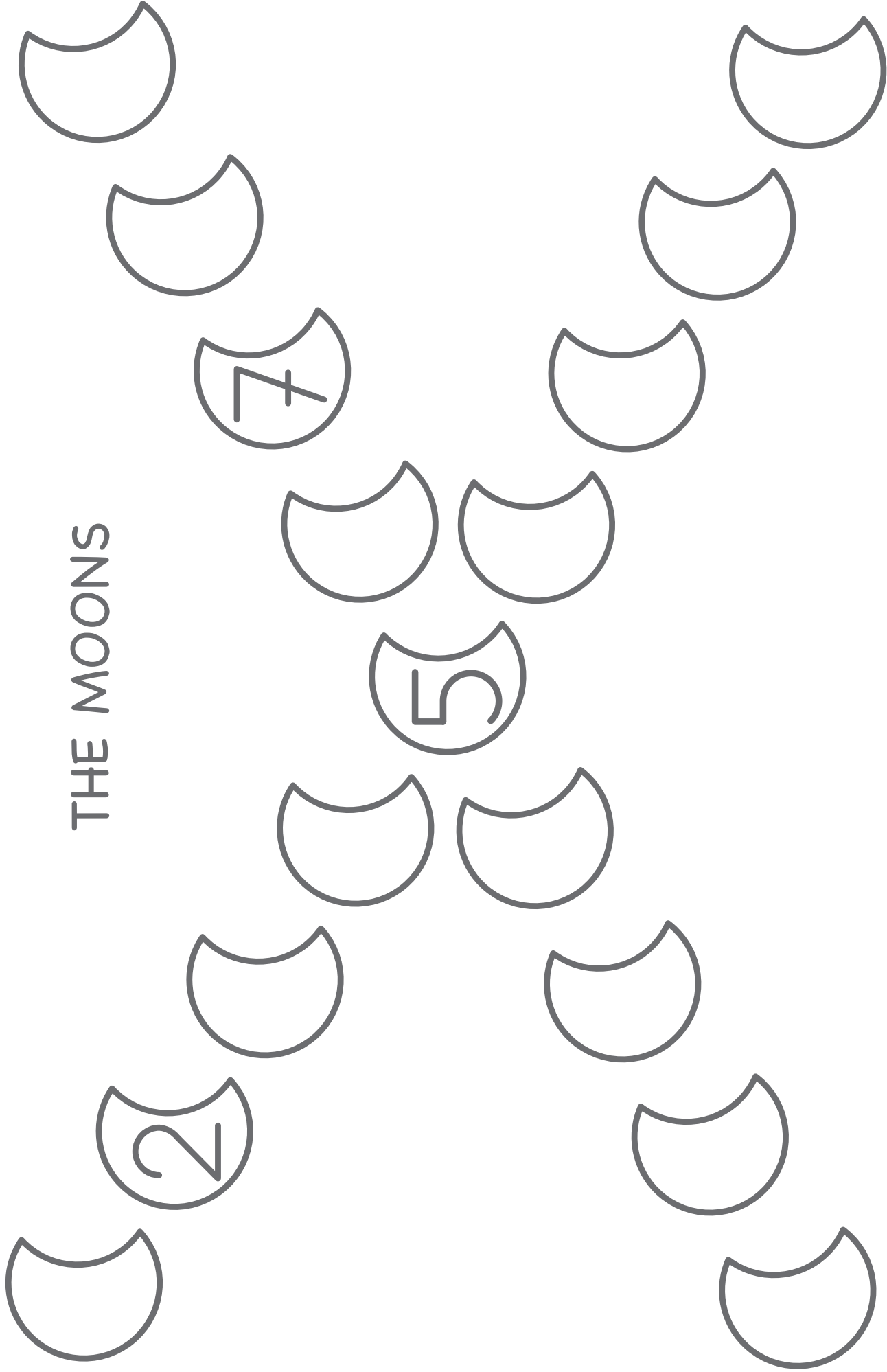

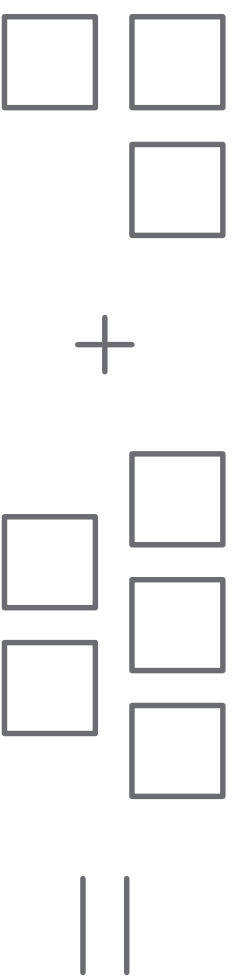
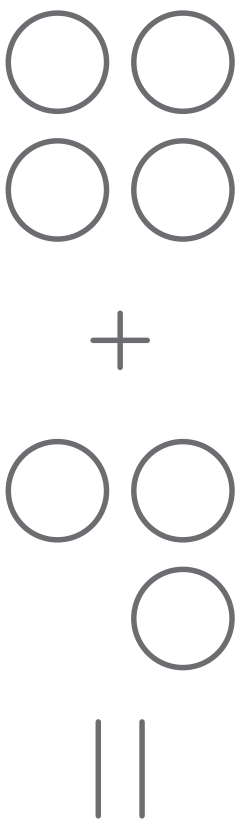

$$\begin{array}{r} 5 \\ + 2 \\ \hline \end{array}$$

$$\begin{array}{r} 3 \\ + 3 \\ \hline \end{array}$$

$$\begin{array}{r} 5 \\ + 1 \\ \hline \end{array}$$

$$\begin{array}{r} 4 \\ + 3 \\ \hline \end{array}$$

$$\begin{array}{r} 7 \\ + 2 \\ \hline \end{array}$$

$$\begin{array}{r} 6 \\ + 3 \\ \hline \end{array}$$

$$\begin{array}{r} 2 \\ + 1 \\ \hline \end{array}$$

$$\begin{array}{r} 8 \\ + 1 \\ \hline \end{array}$$

$$\begin{array}{r} 1 \\ + 4 \\ \hline \end{array}$$

$$\begin{array}{r} 2 \\ + 4 \\ \hline \end{array}$$

$$\begin{array}{r} 3 \\ + 6 \\ \hline \end{array}$$

$$\begin{array}{r} 5 \\ + 4 \\ \hline \end{array}$$

$$\begin{array}{r} 7 \\ + 1 \\ \hline \end{array}$$

$$\begin{array}{r} 5 \\ + 3 \\ \hline \end{array}$$

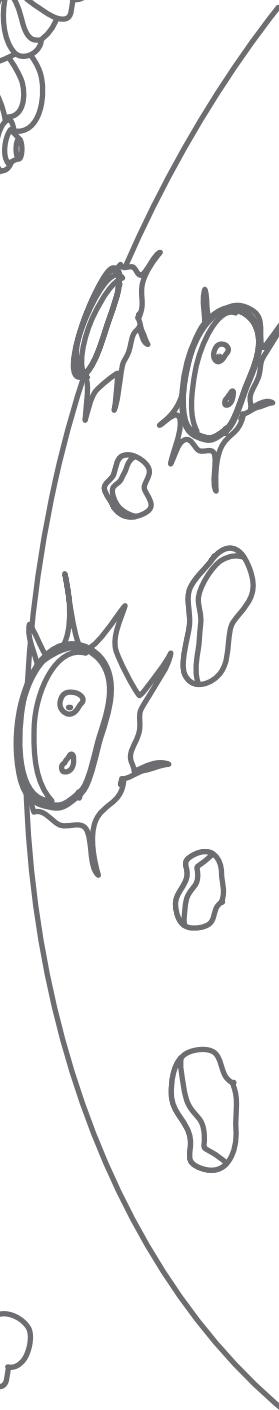
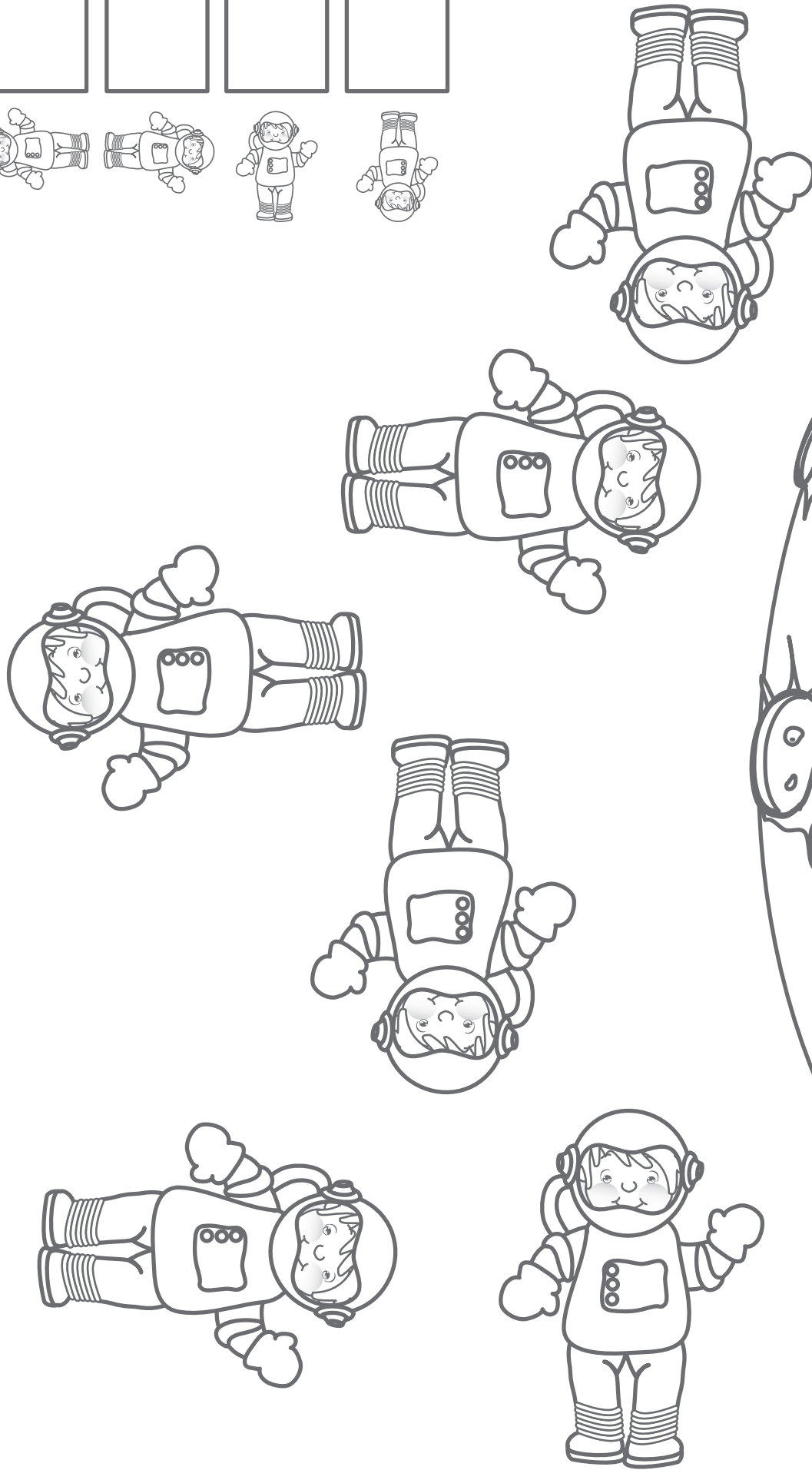
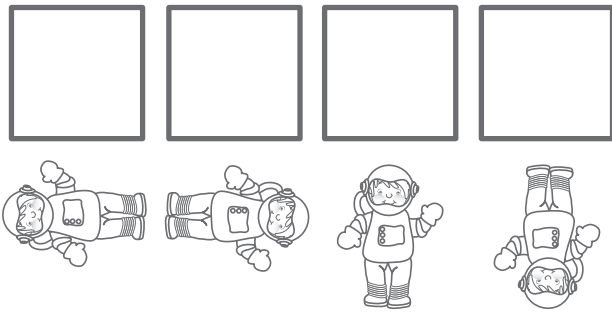

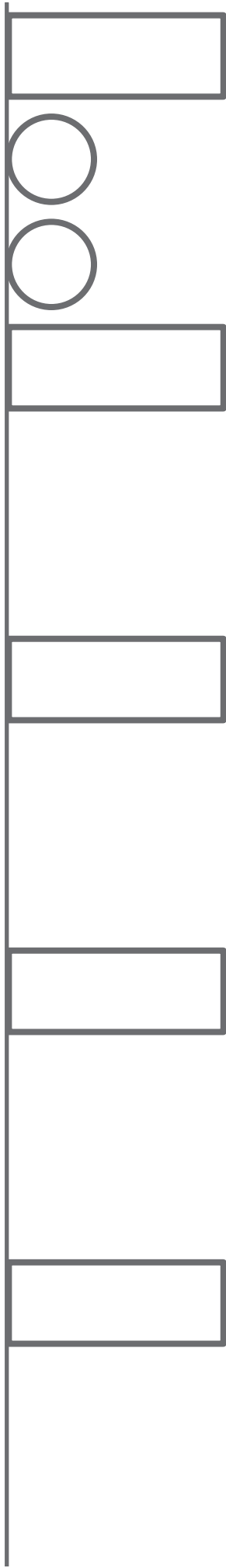
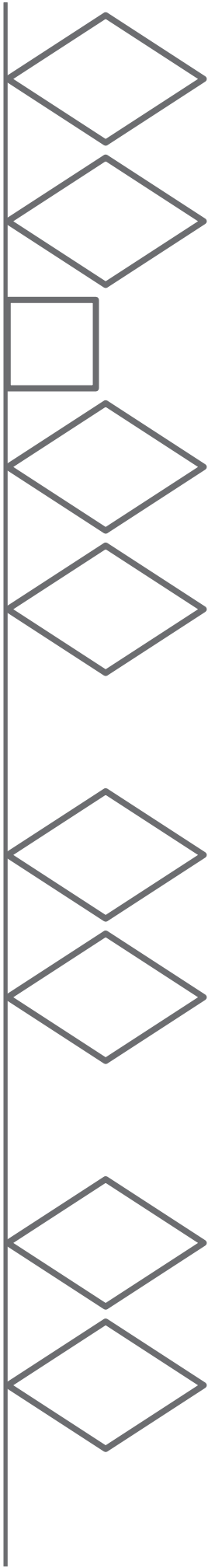

CIRCLE

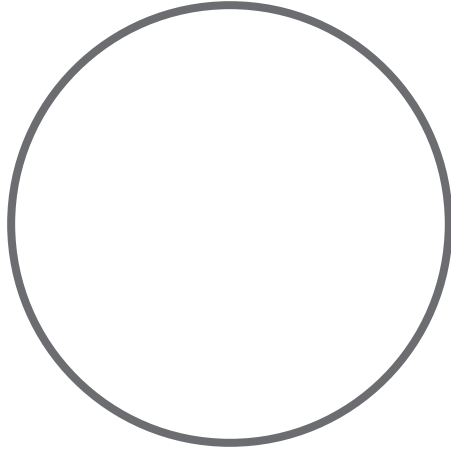

SQUARE

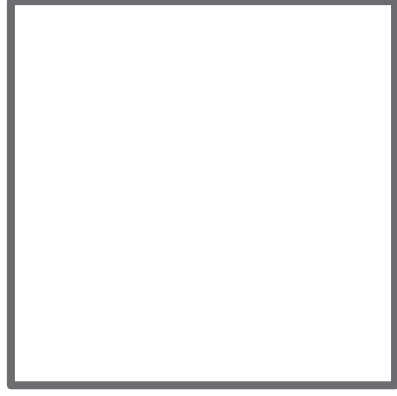

TRIANGLE

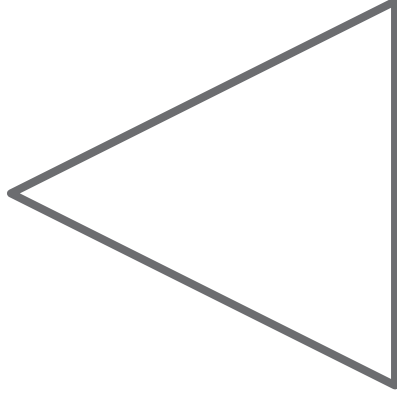

DIAMOND

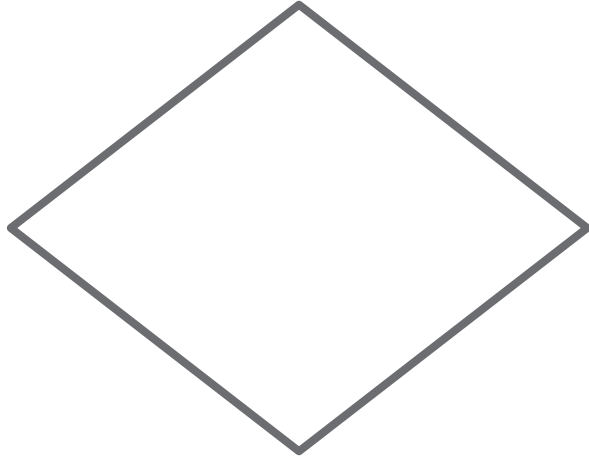

RECTANGLE

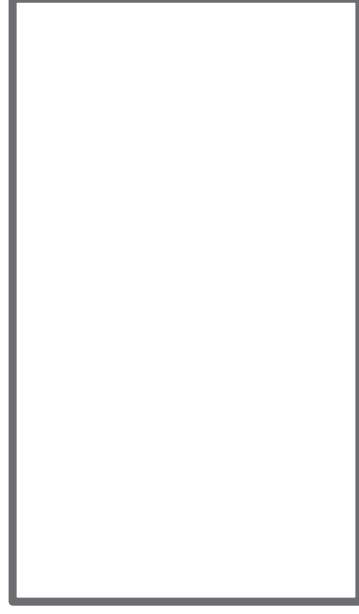

OVAL

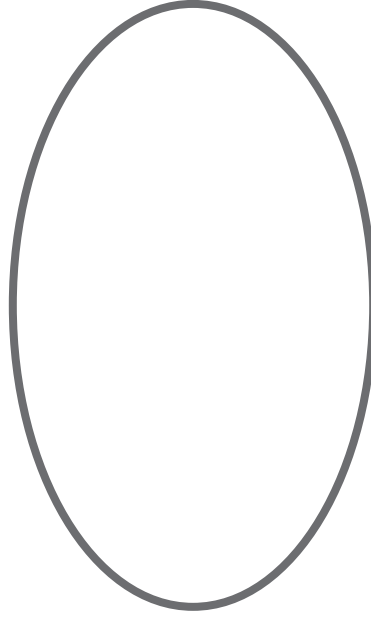

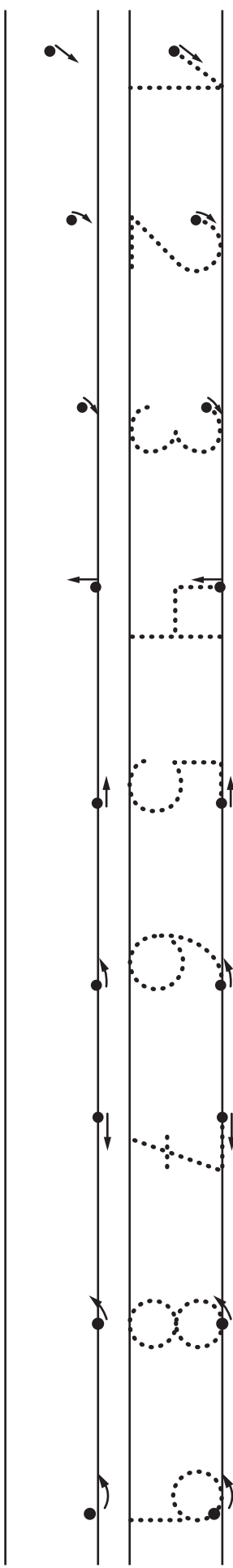
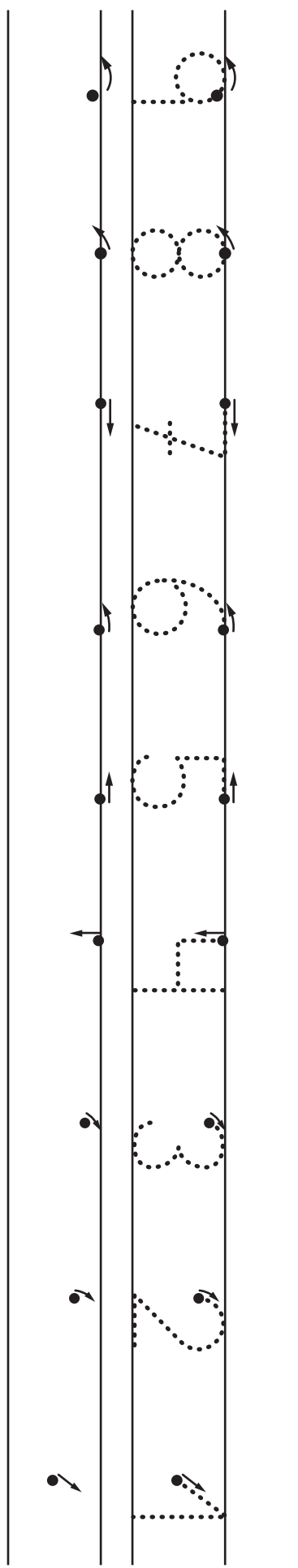
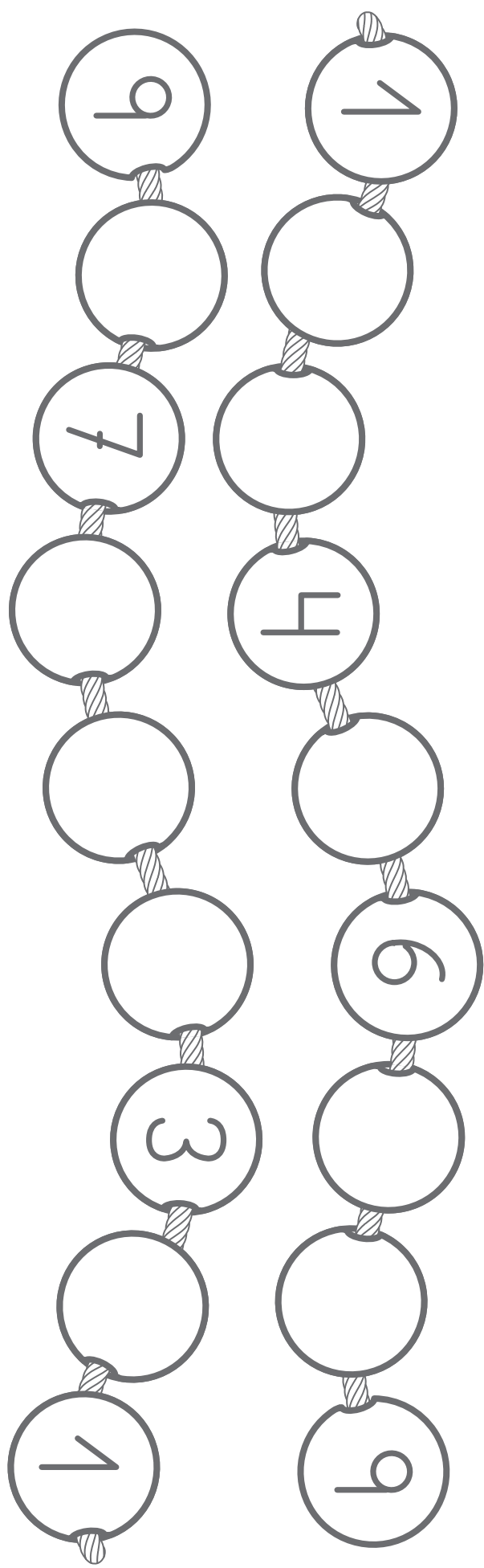

MY ACTIVITIES

MONDAY

.....

TUESDAY

.....

WEDNESDAY

.....

THURSDAY

.....

MY WEEK

SUNDAY

.....

SATURDAY

.....

FRIDAY

.....

IT'S WINTER

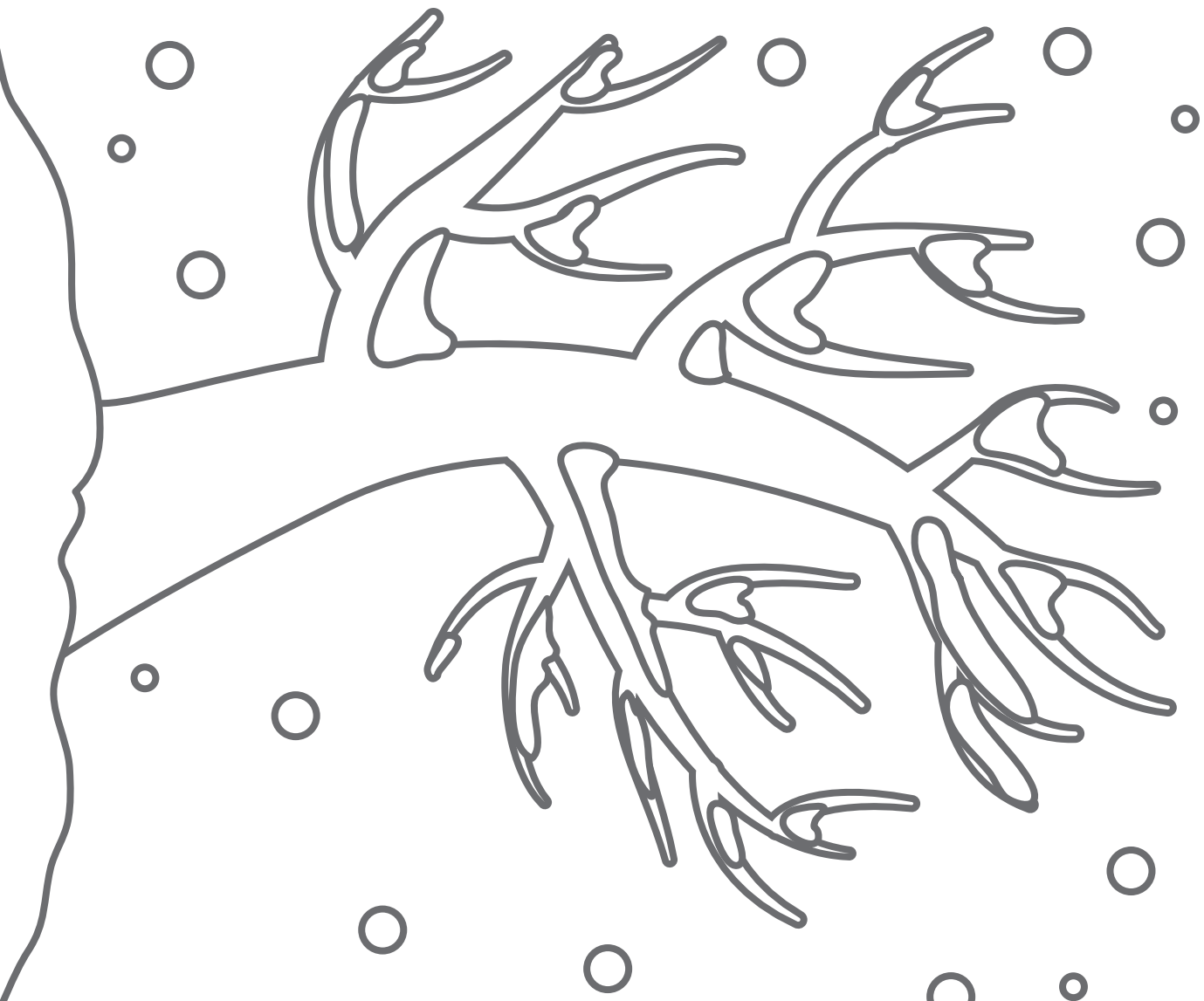

WHAT'S THE WEATHER
LIKE TODAY?

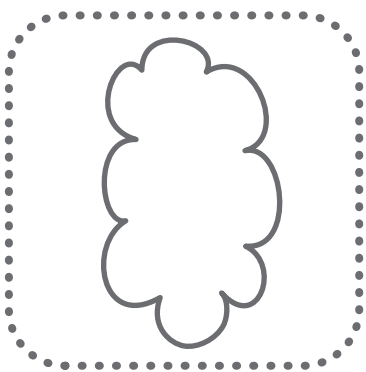
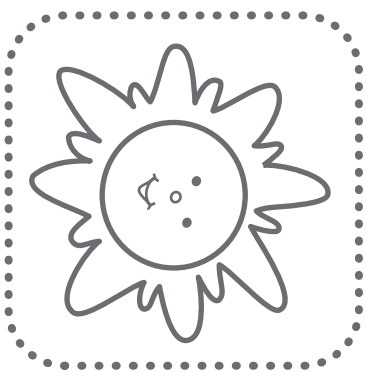
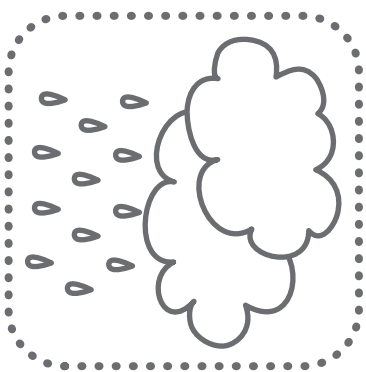

DAY

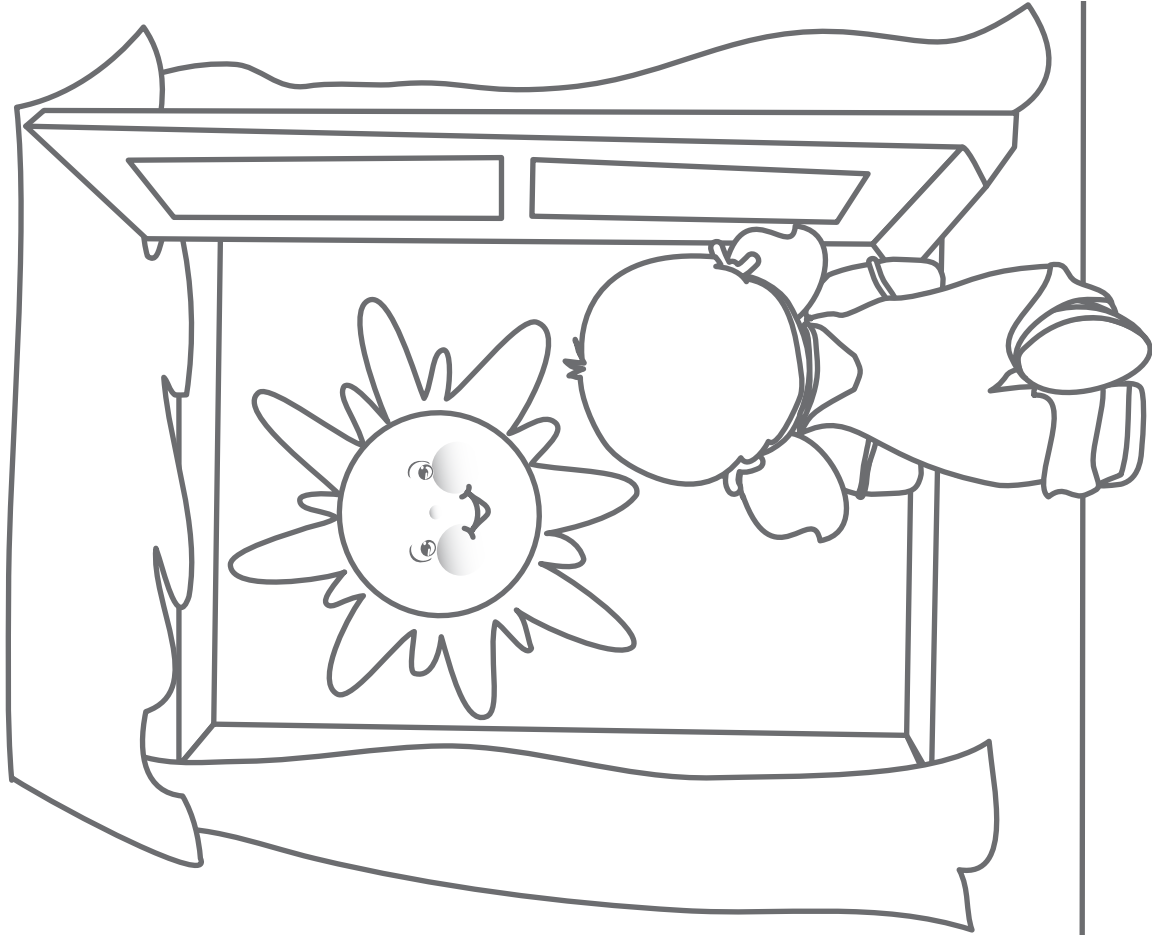

NIGHT

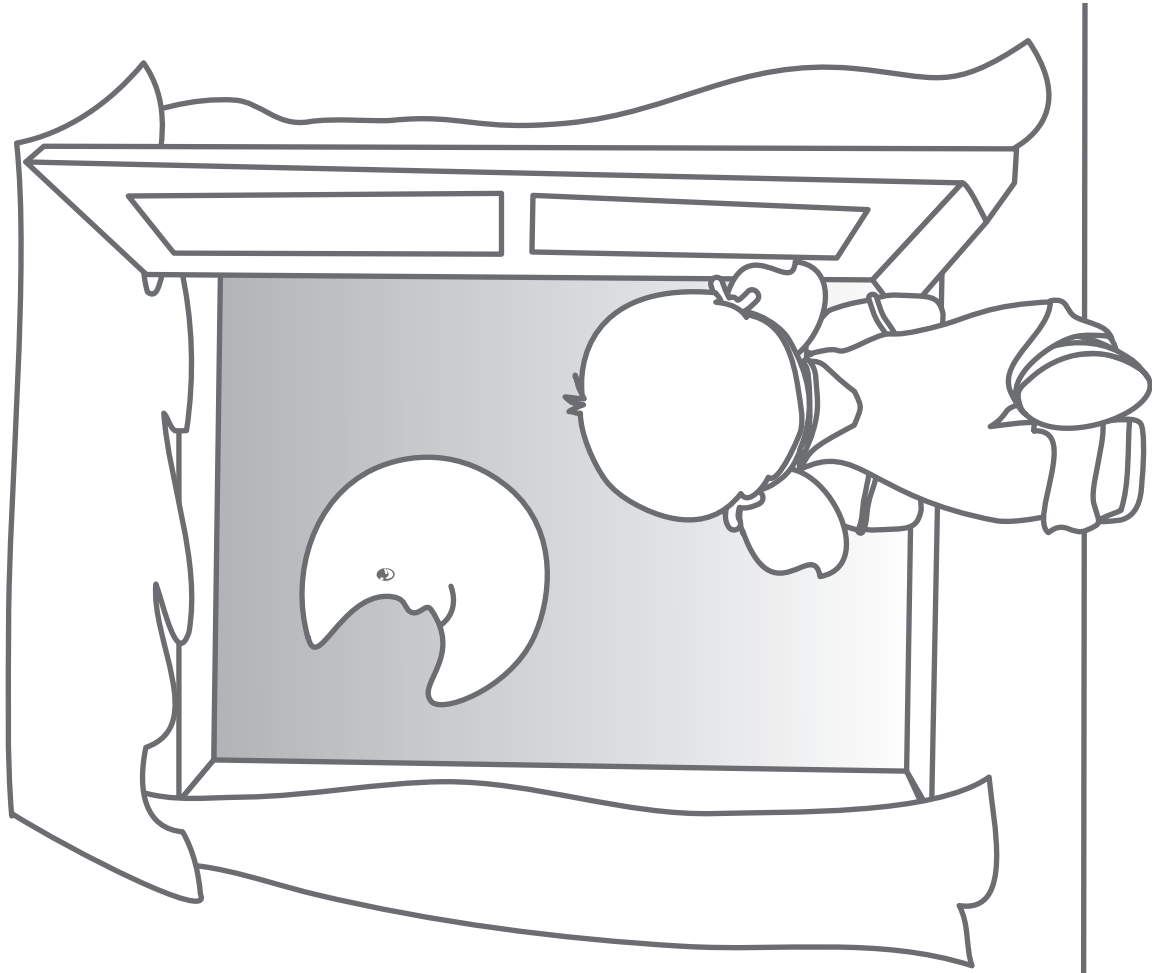

MY CONSTELLATION



THE SUN

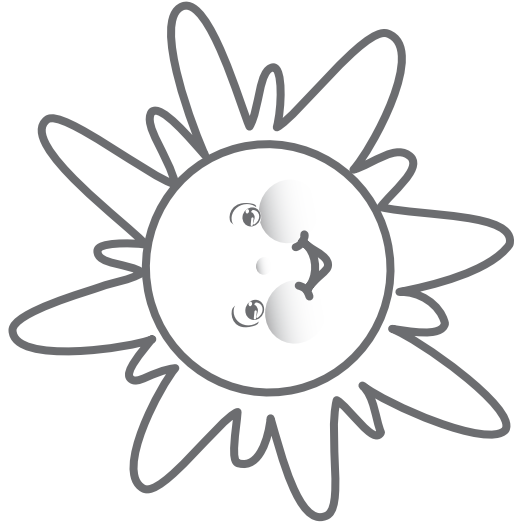

THE MOON

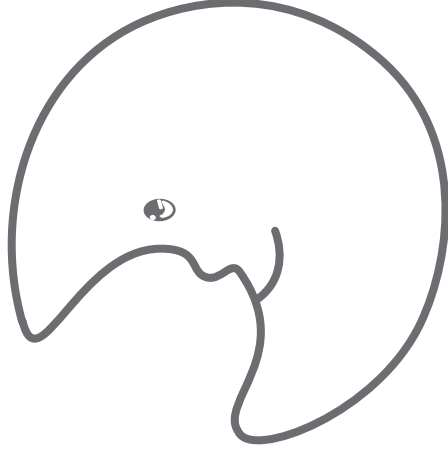

THE EARTH



PLANET

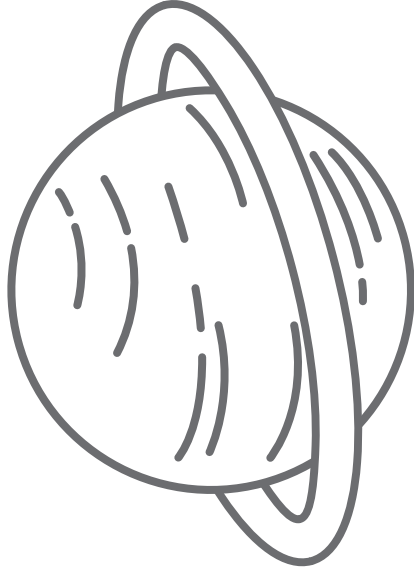

STARS



SPACE SHIP

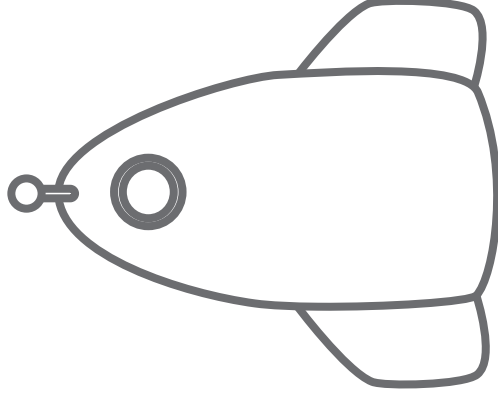

HELMET

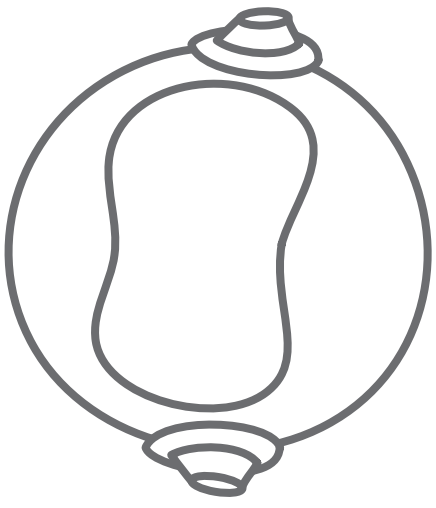

BOOTS

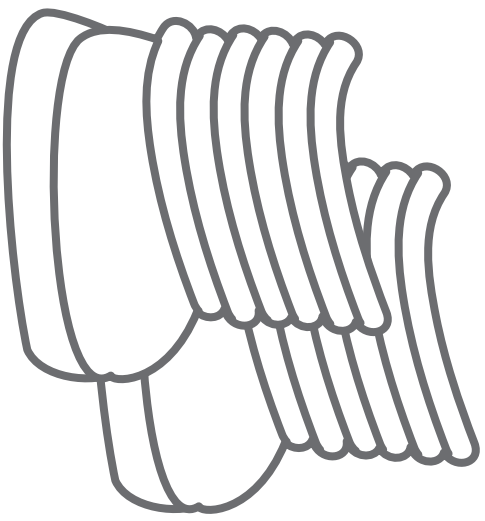

ASTRONAUT

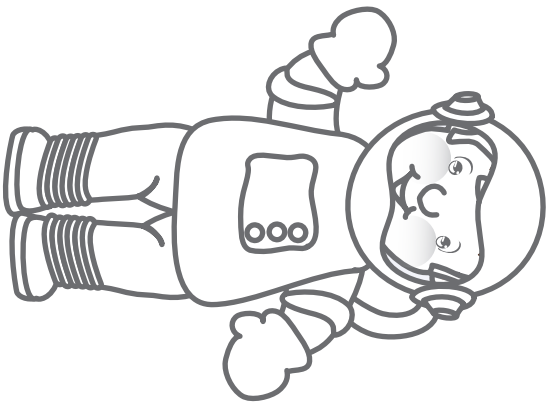

METEORITE

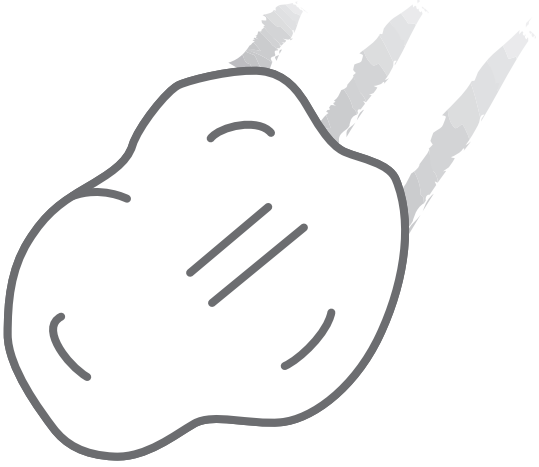

GLOVES

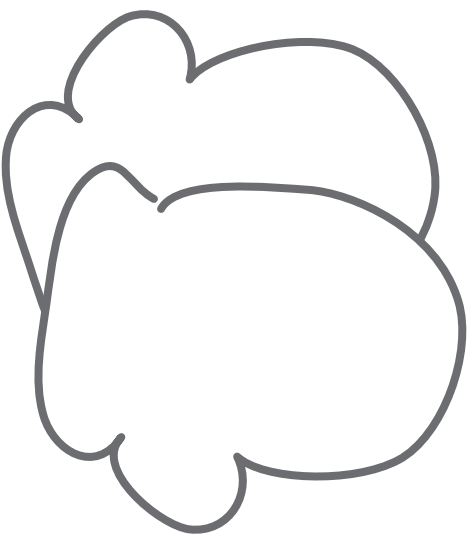

SATELLITE

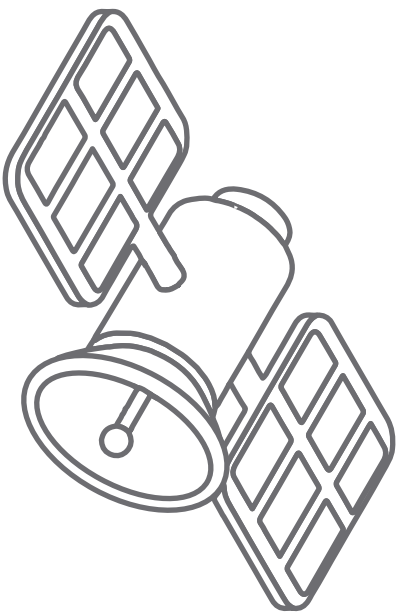

CAT



BEEBLE

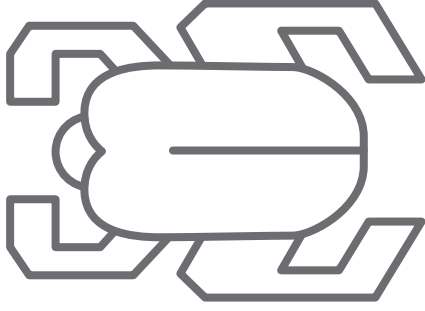

KEY

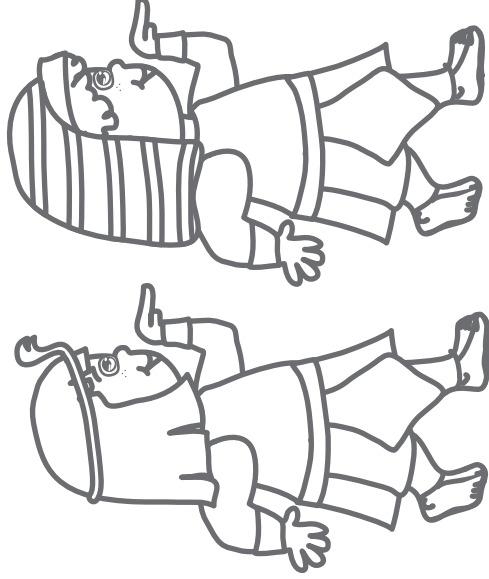
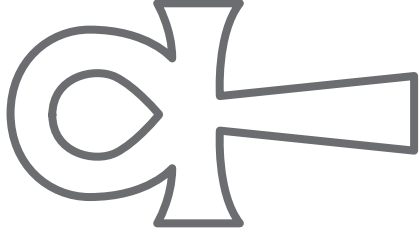

CHILDREN

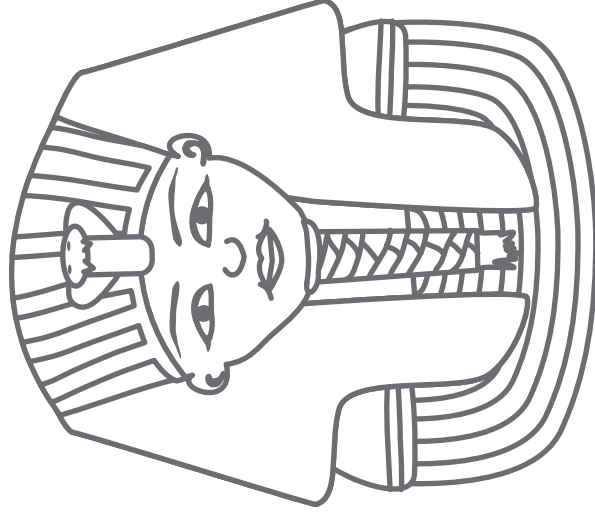

PHARAOH

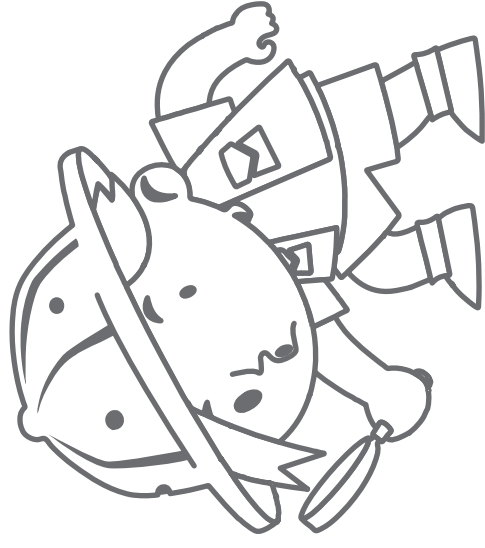

ARCHEOLOGIST

PYRAMID

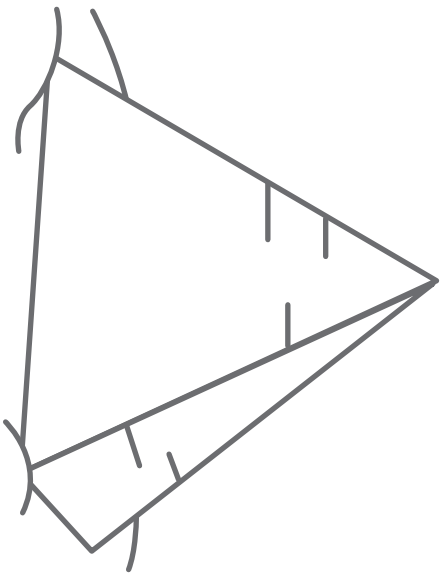

CROCODILE



BOAT

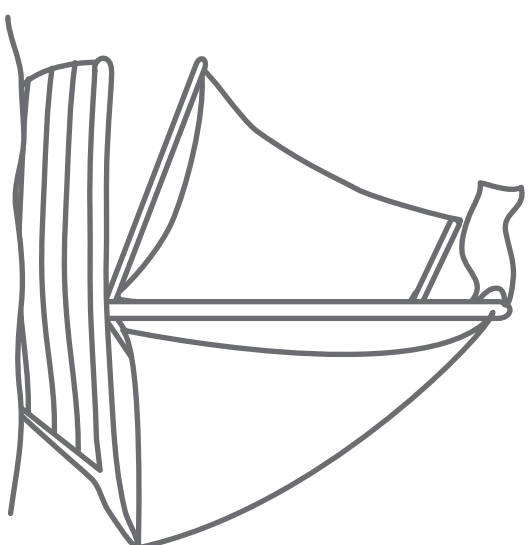

CAMEL

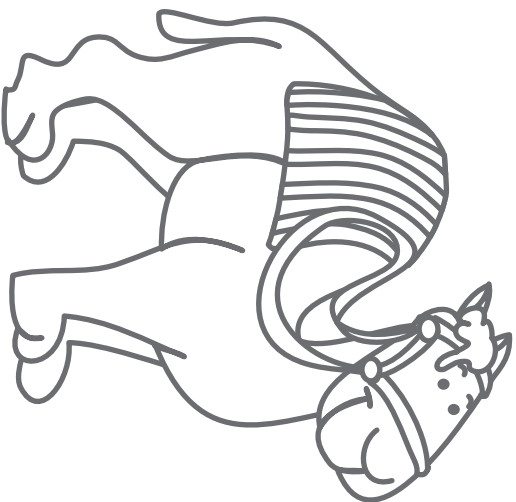

HOUSES

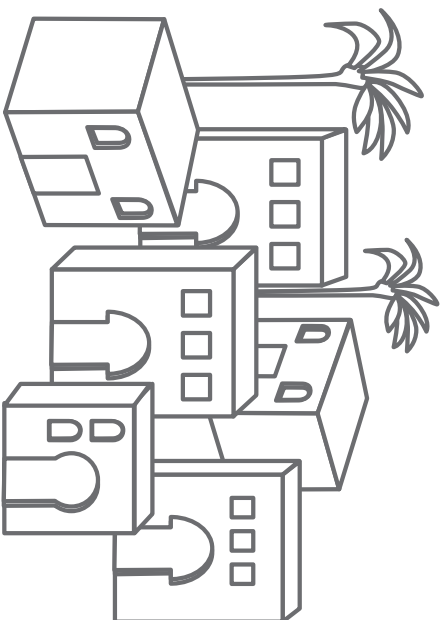

MUMMY

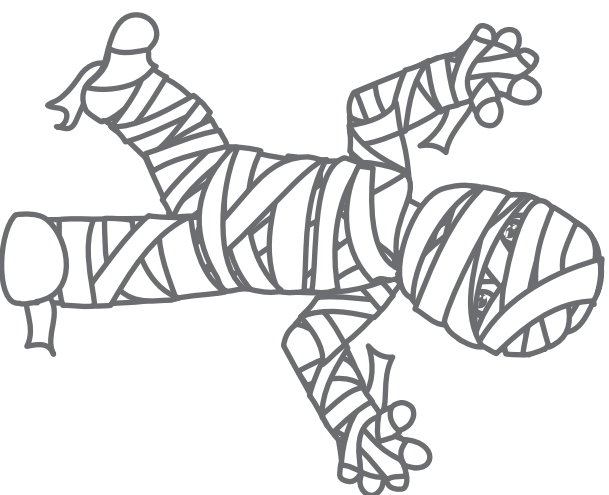

FISH

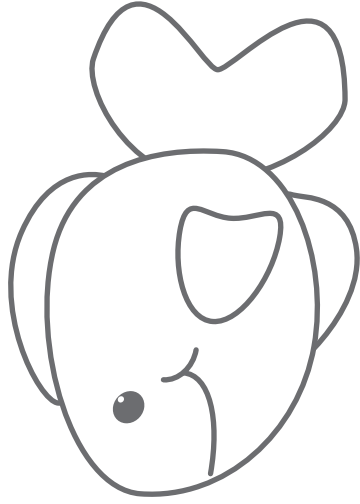

EYE

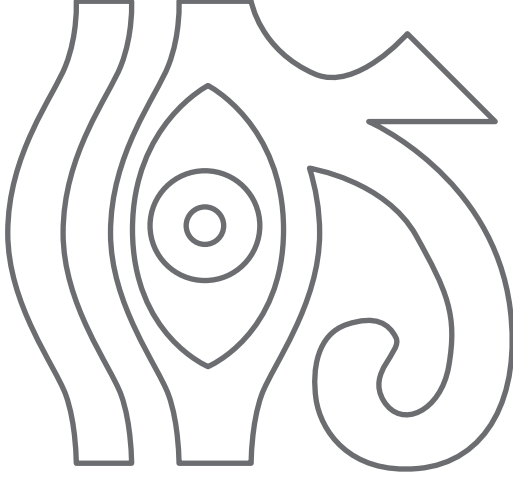

HIPPO

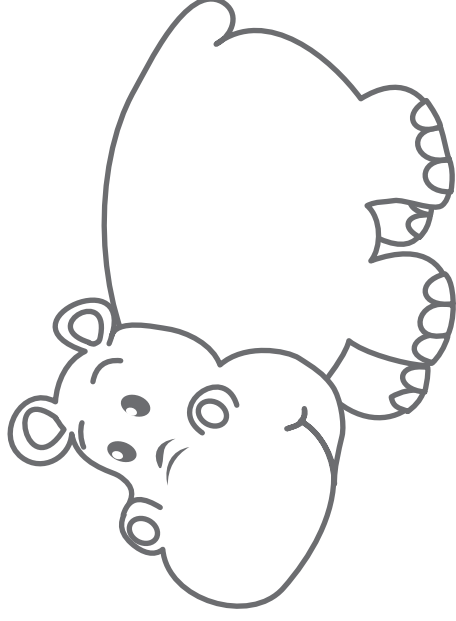

DUCK

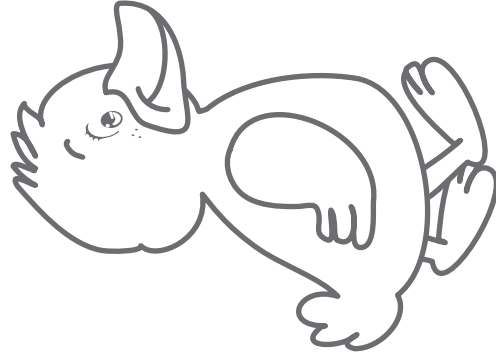

OBELISK

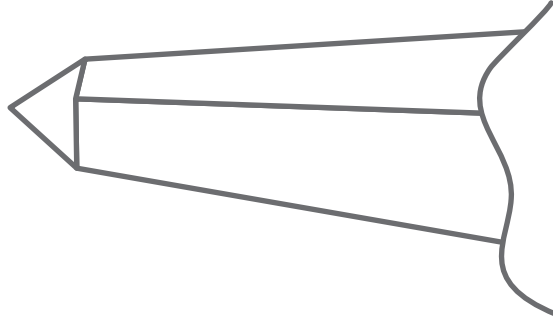

NEFERTITI

