

# MATERIAL FOTOCOPIABLE

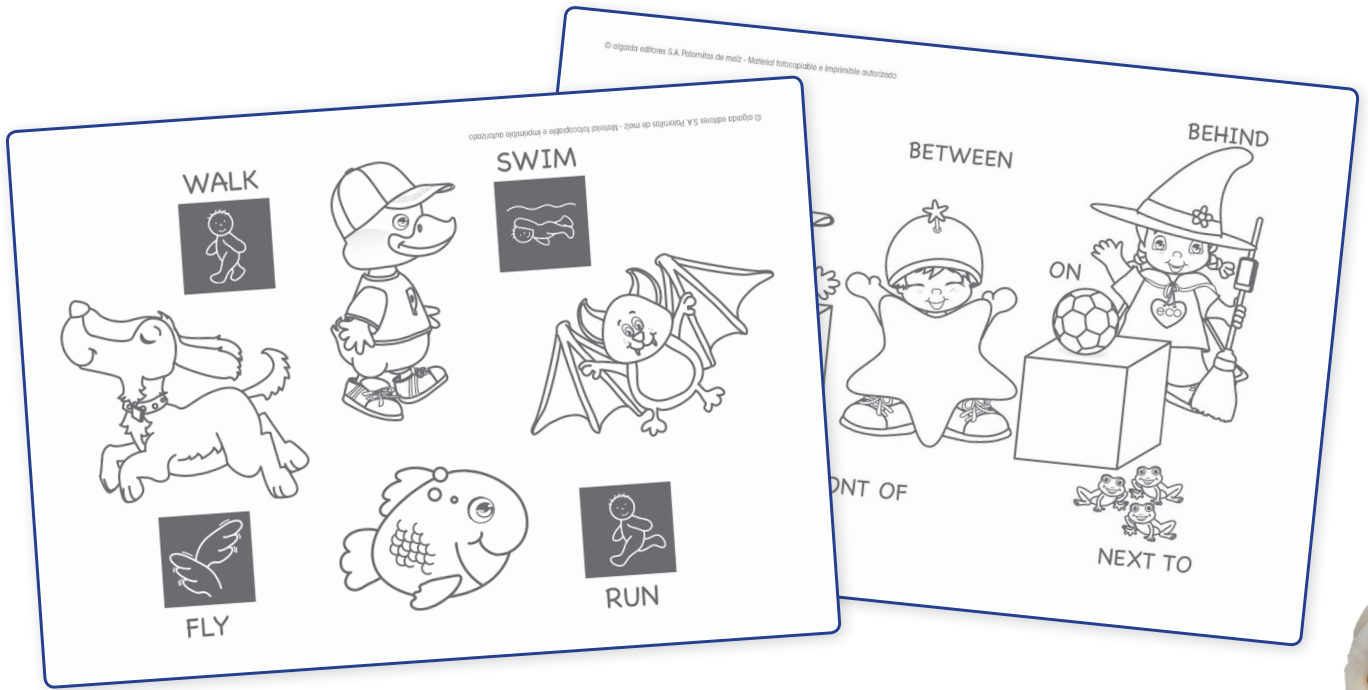

En las fichas fotocopiables de este libro no se incluye ninguna propuesta de actividad para que sea cada docente quien proponga las que considere oportunas teniendo en cuenta las necesidades de sus alumnos y alumnas, su programación didáctica y su realidad educativa. Se incluyen palabras y expresiones muy sencillas en inglés para complementar la iniciación en el aprendizaje de esta lengua.



# MOUNTAINS

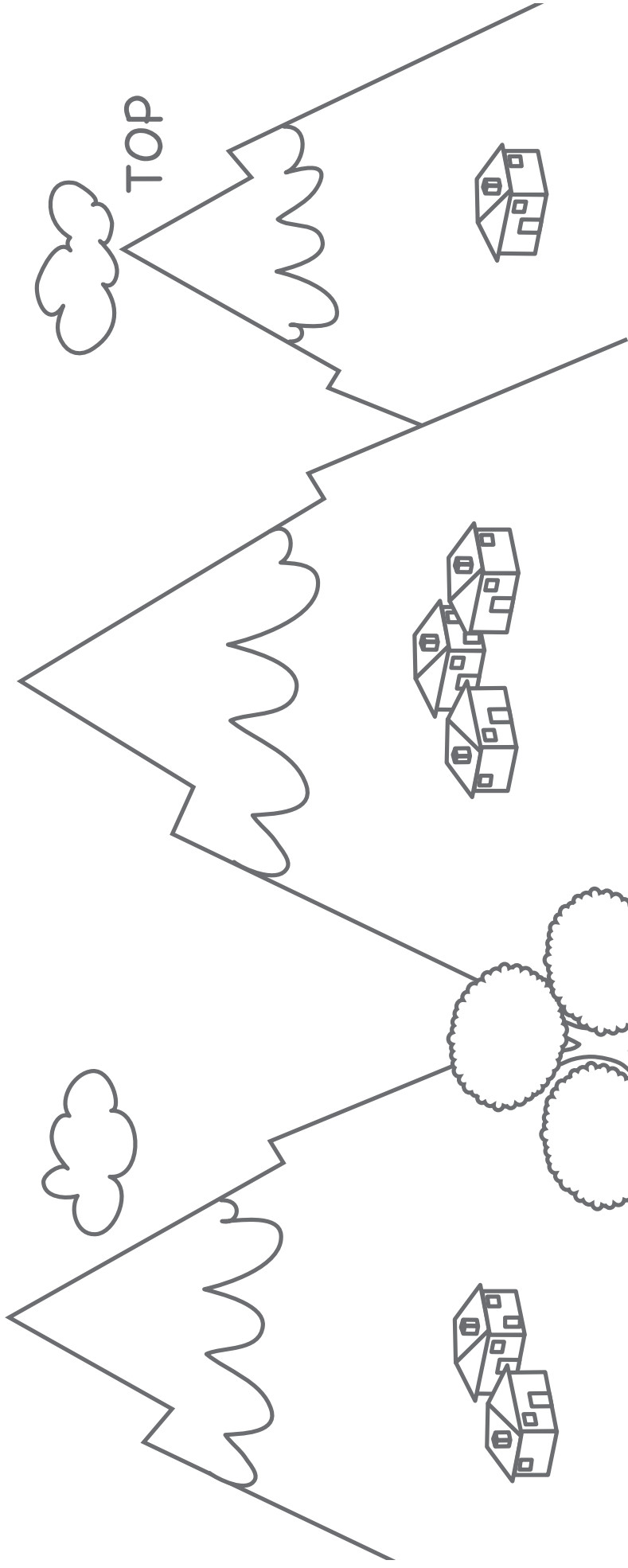

BETWEEN

How many objects are between the two mountains? Write the number in the boxes.

HOW MANY?

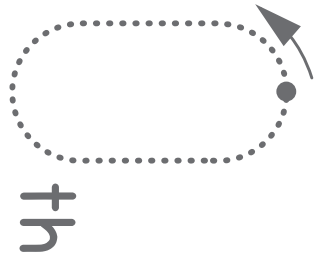

th

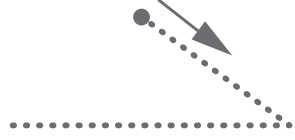

th



th



th



th

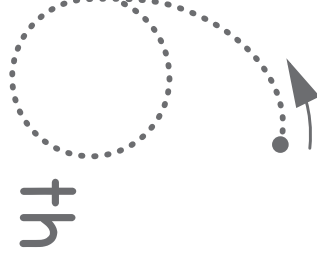

th



th

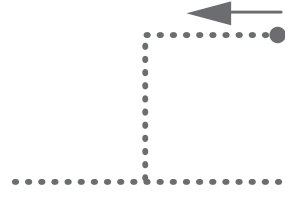

th



rd

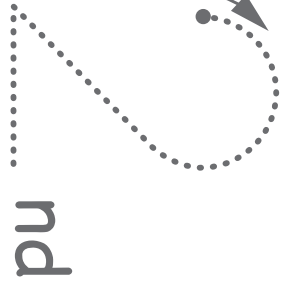

nd

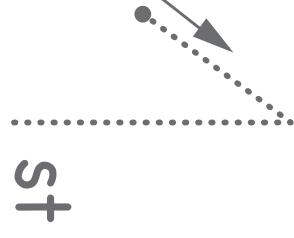

st

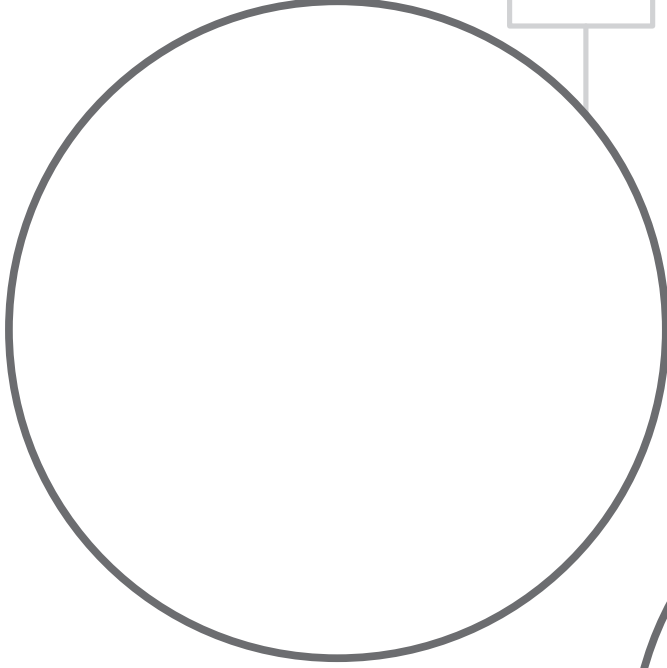

4040

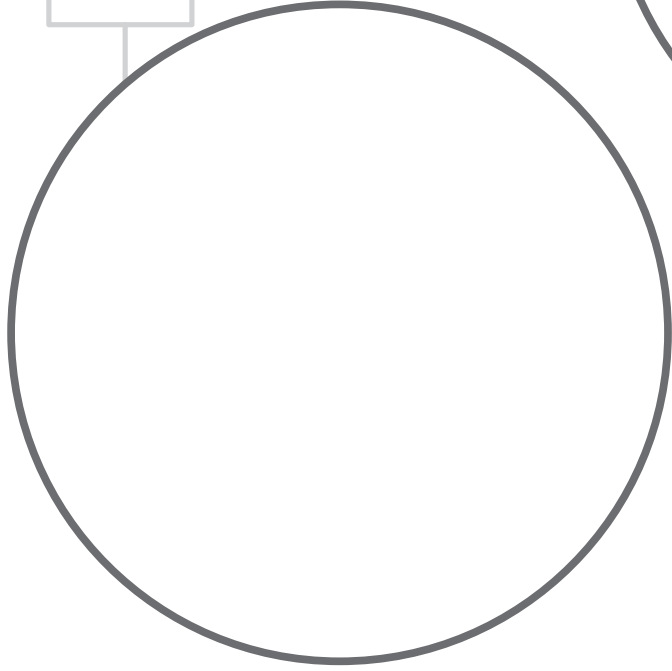

7□

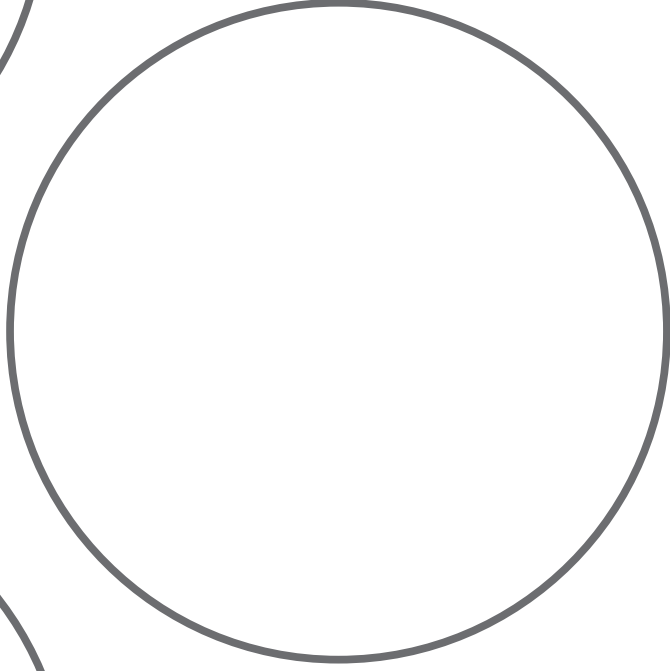

5△3△

NEAR

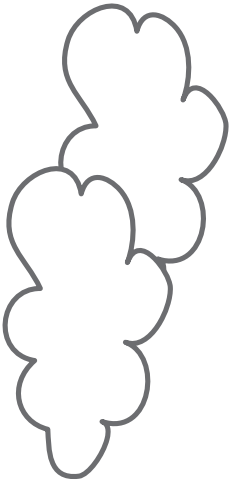
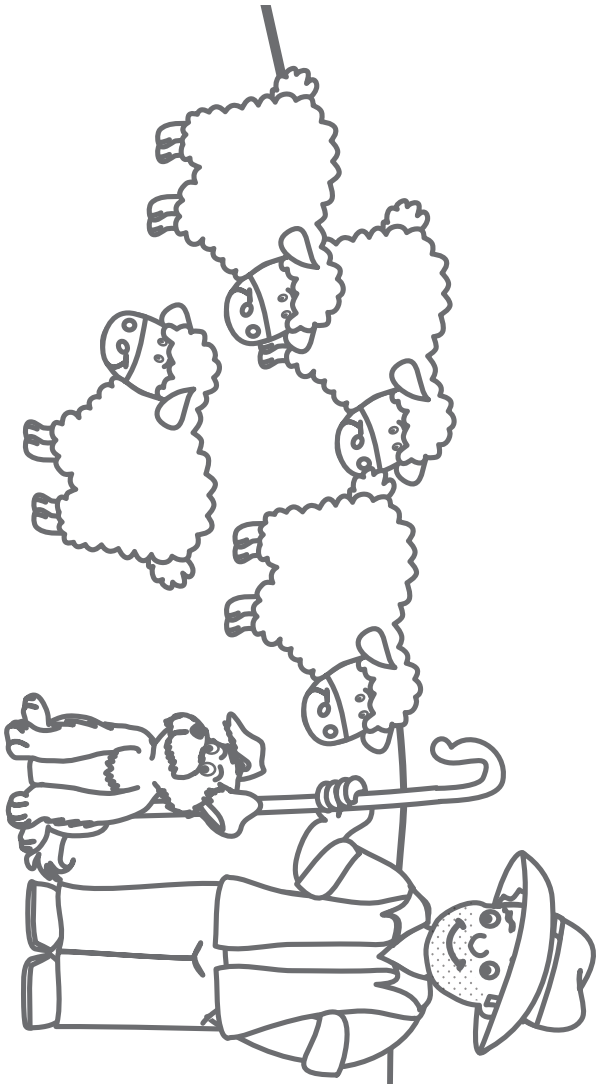

FAR

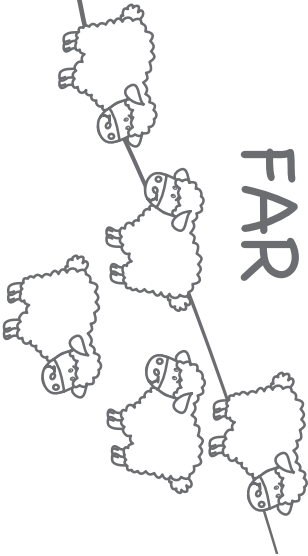

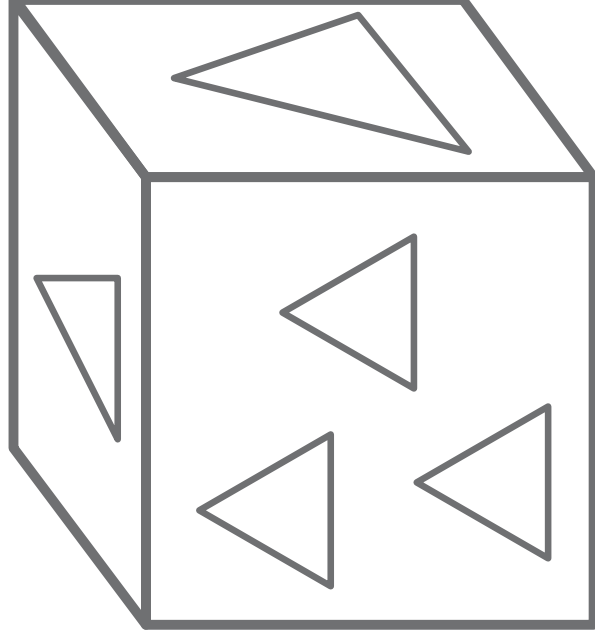
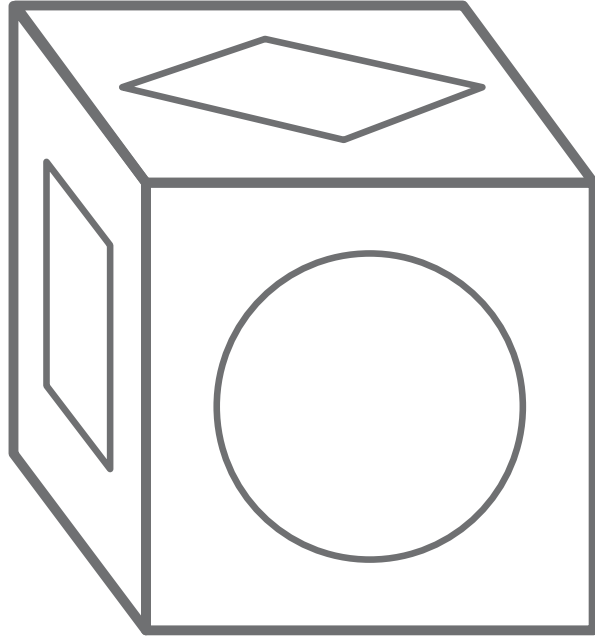
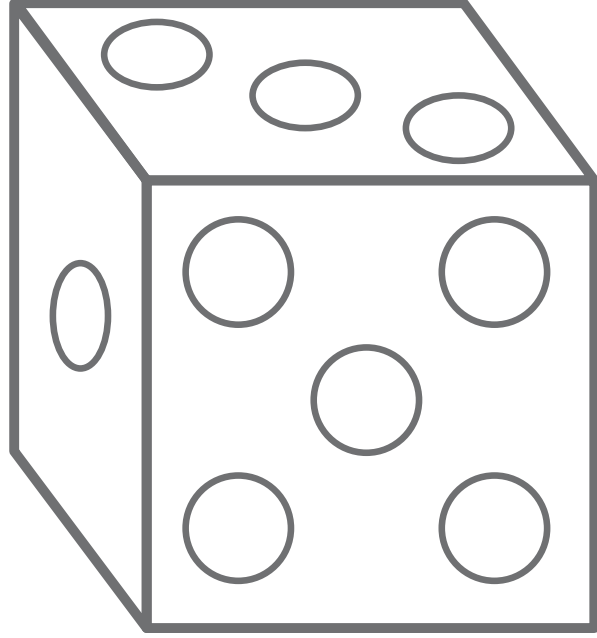

CUBE

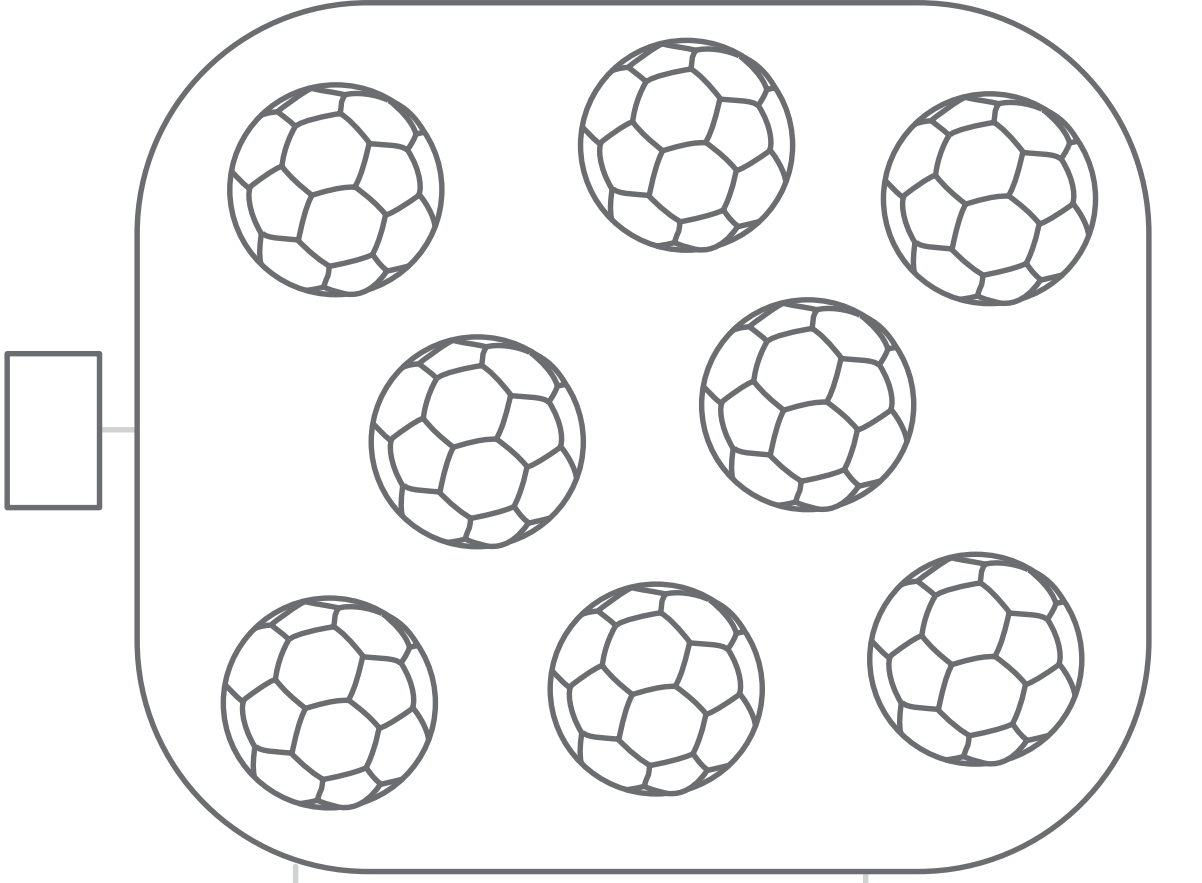
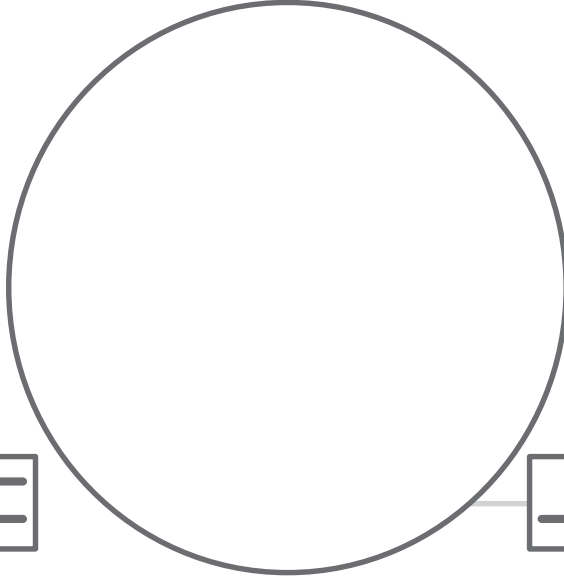
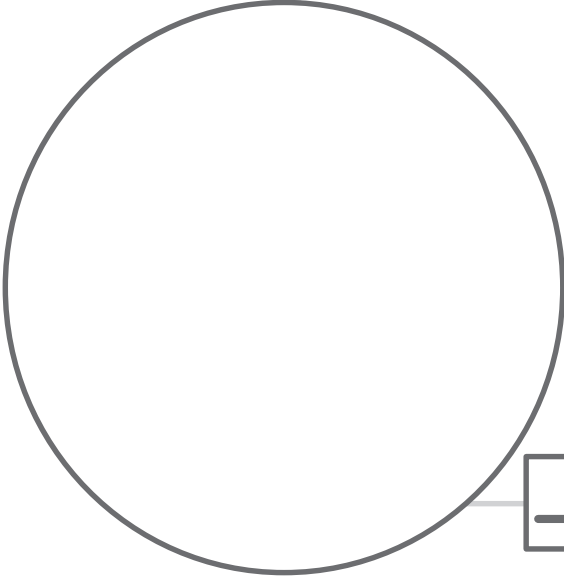
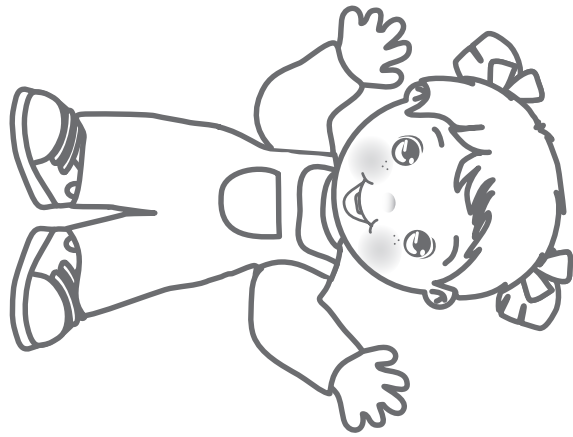
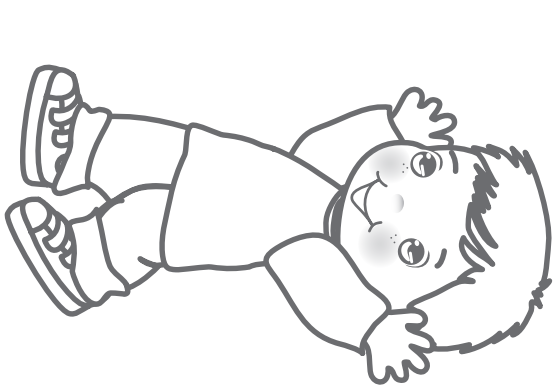



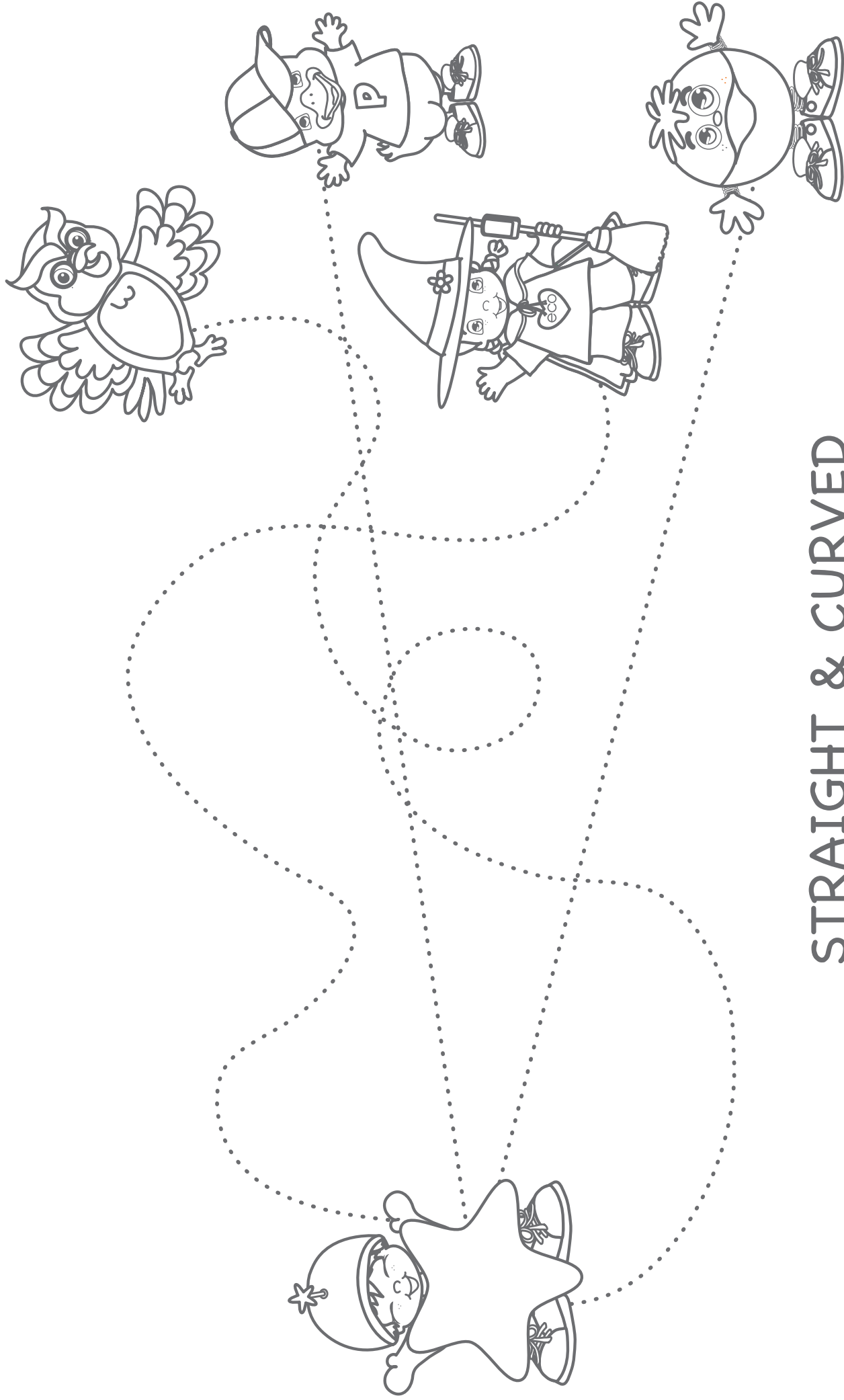

**STRAIGHT & CURVED**

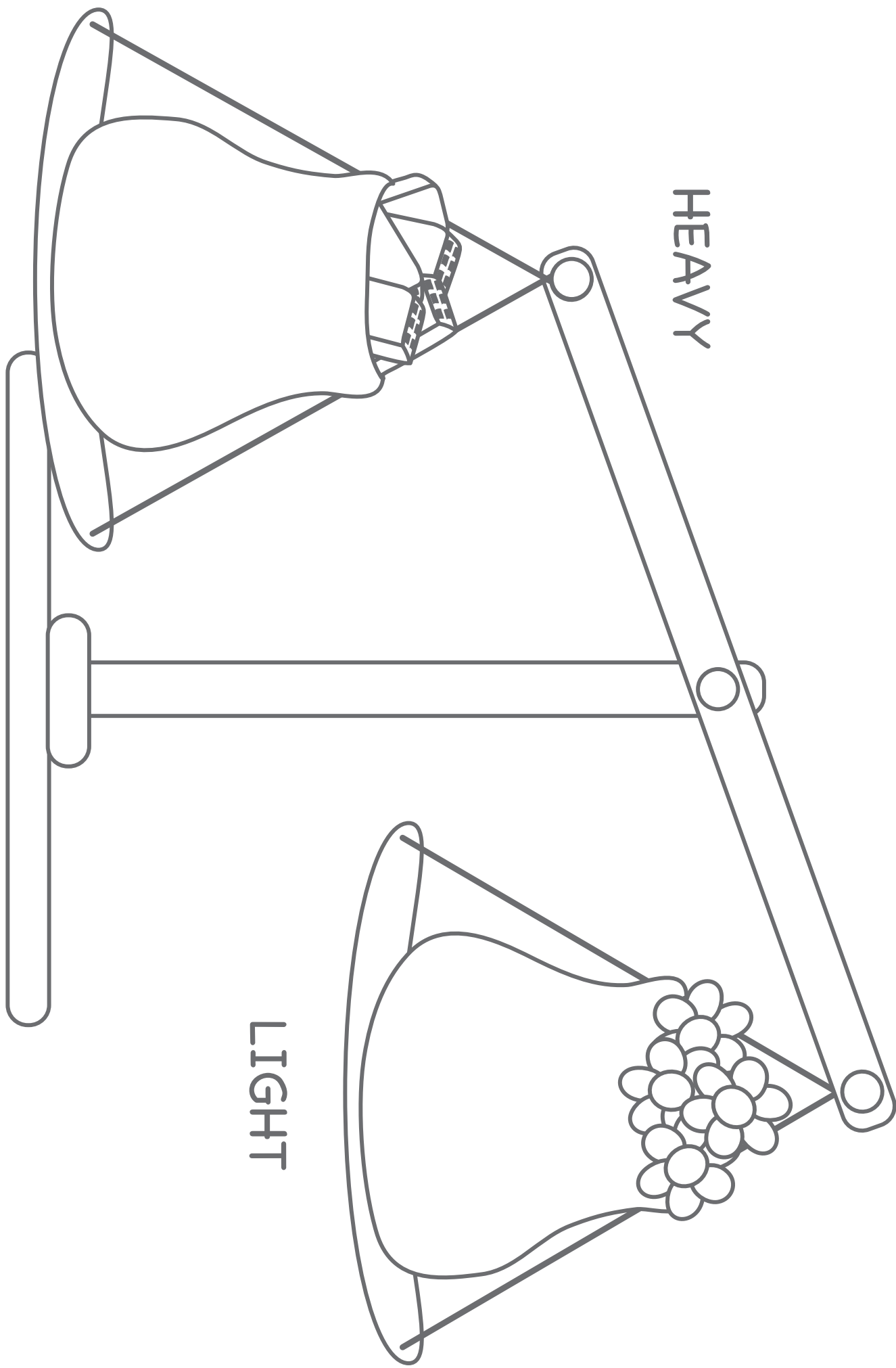

# SPHERE

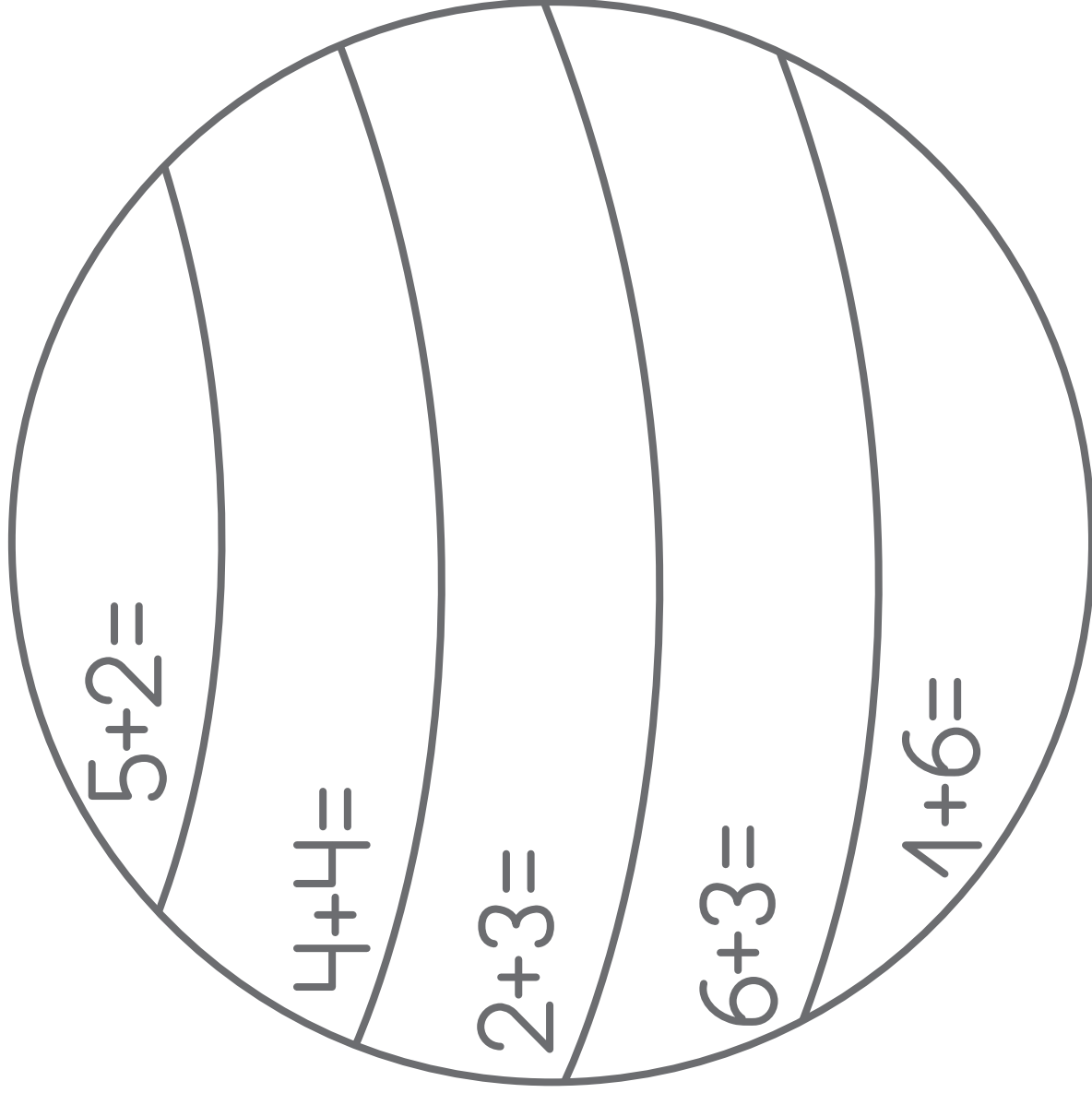

5

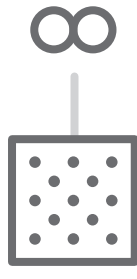

8



7



9

FLY

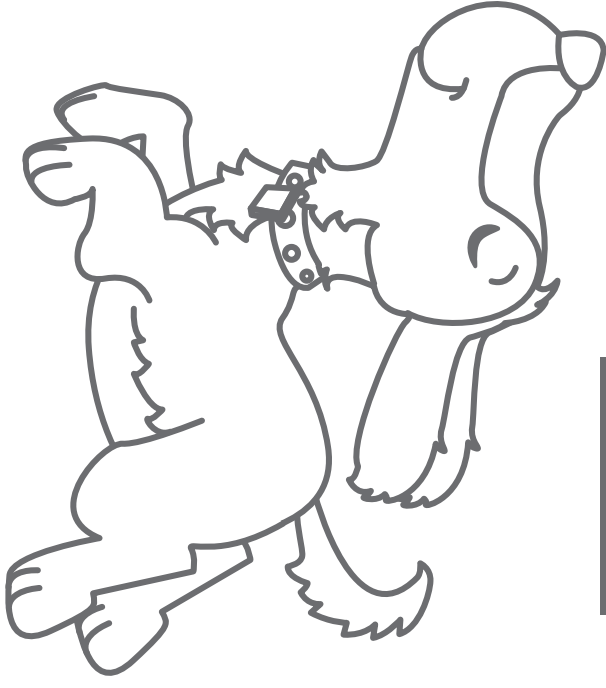

WALK

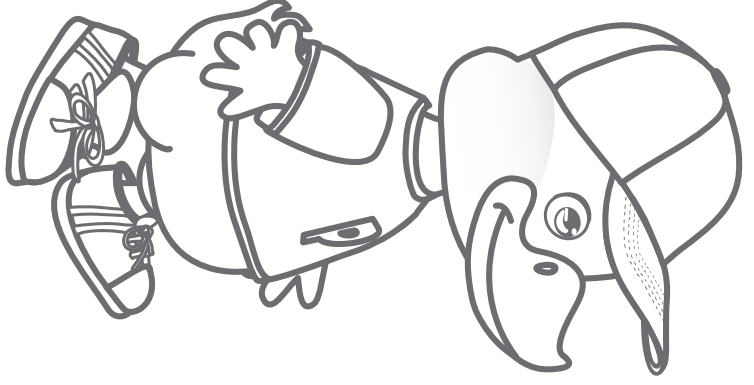
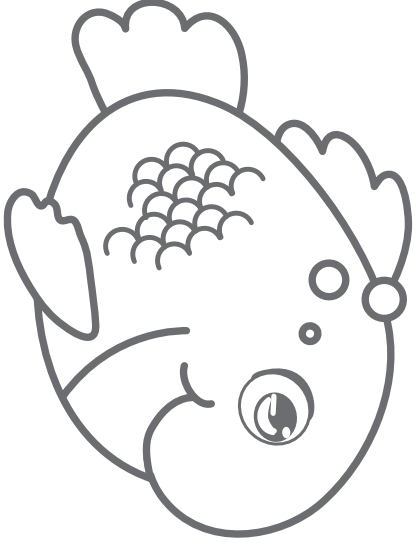
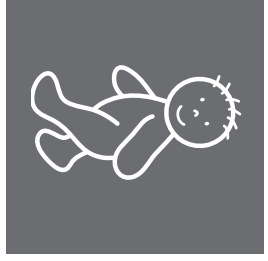

SWIM



RUN

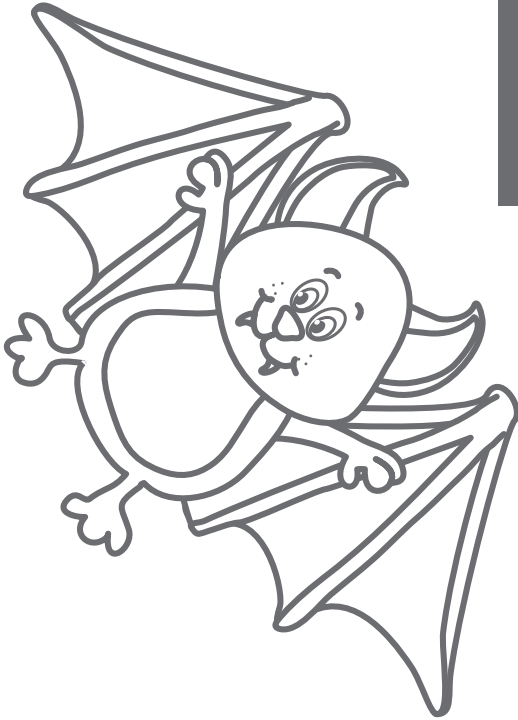
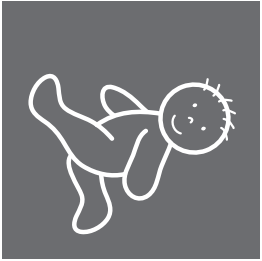

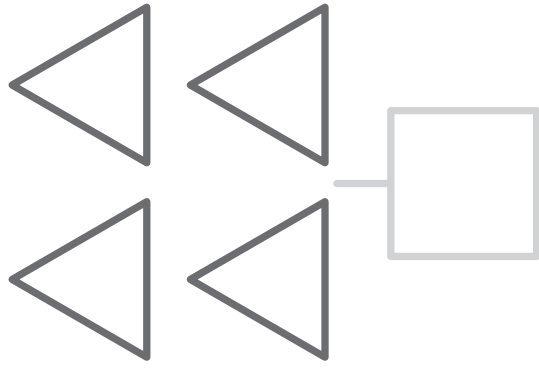

=

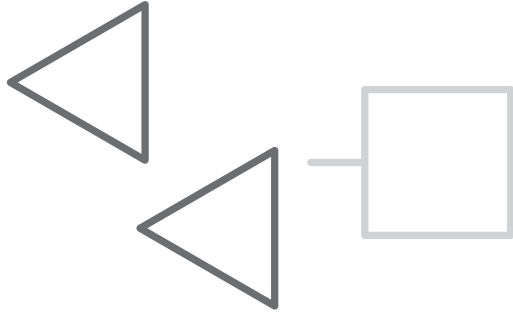

=



=

+



IN

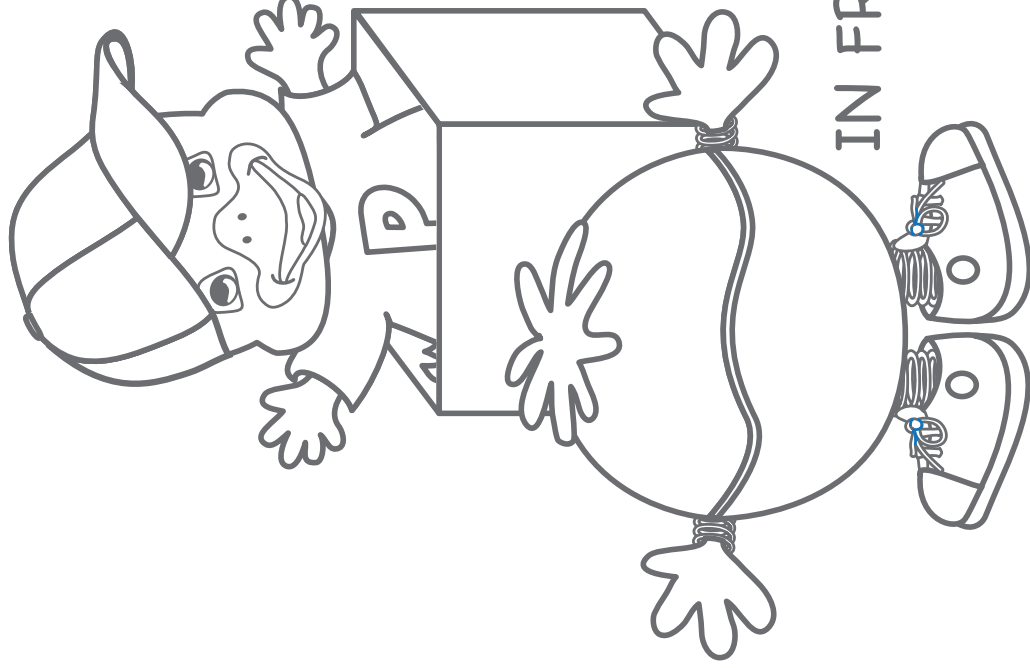

IN FRONT OF

BETWEEN

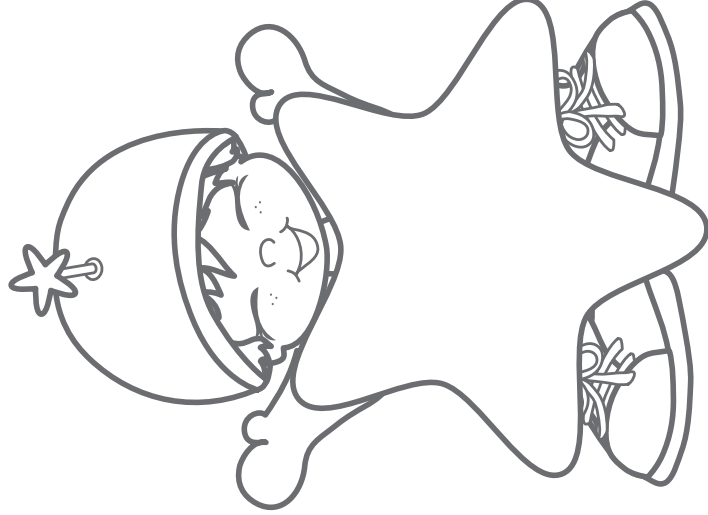

BEHIND

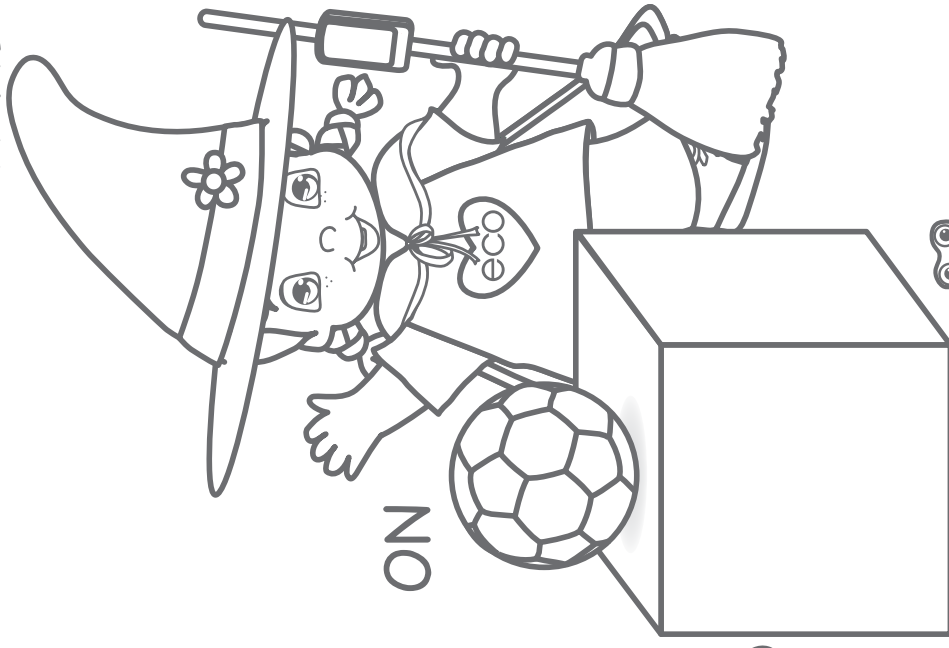

ON

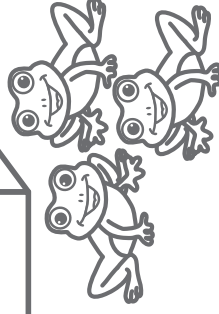

NEXT TO

$$\begin{array}{r} 5 \\ + 2 \\ \hline \end{array}$$

$$\begin{array}{r} 4 \\ + 3 \\ \hline \end{array}$$

$$\begin{array}{r} 2 \\ + 2 \\ \hline \end{array}$$

$$\begin{array}{r} 5 \\ + 3 \\ \hline \end{array}$$

$$\begin{array}{r} 3 \\ + 6 \\ \hline \end{array}$$

$$\begin{array}{r} 8 \\ + 1 \\ \hline \end{array}$$

$$\begin{array}{r} 7 \\ + 2 \\ \hline \end{array}$$

$$\begin{array}{r} 4 \\ + 6 \\ \hline \end{array}$$



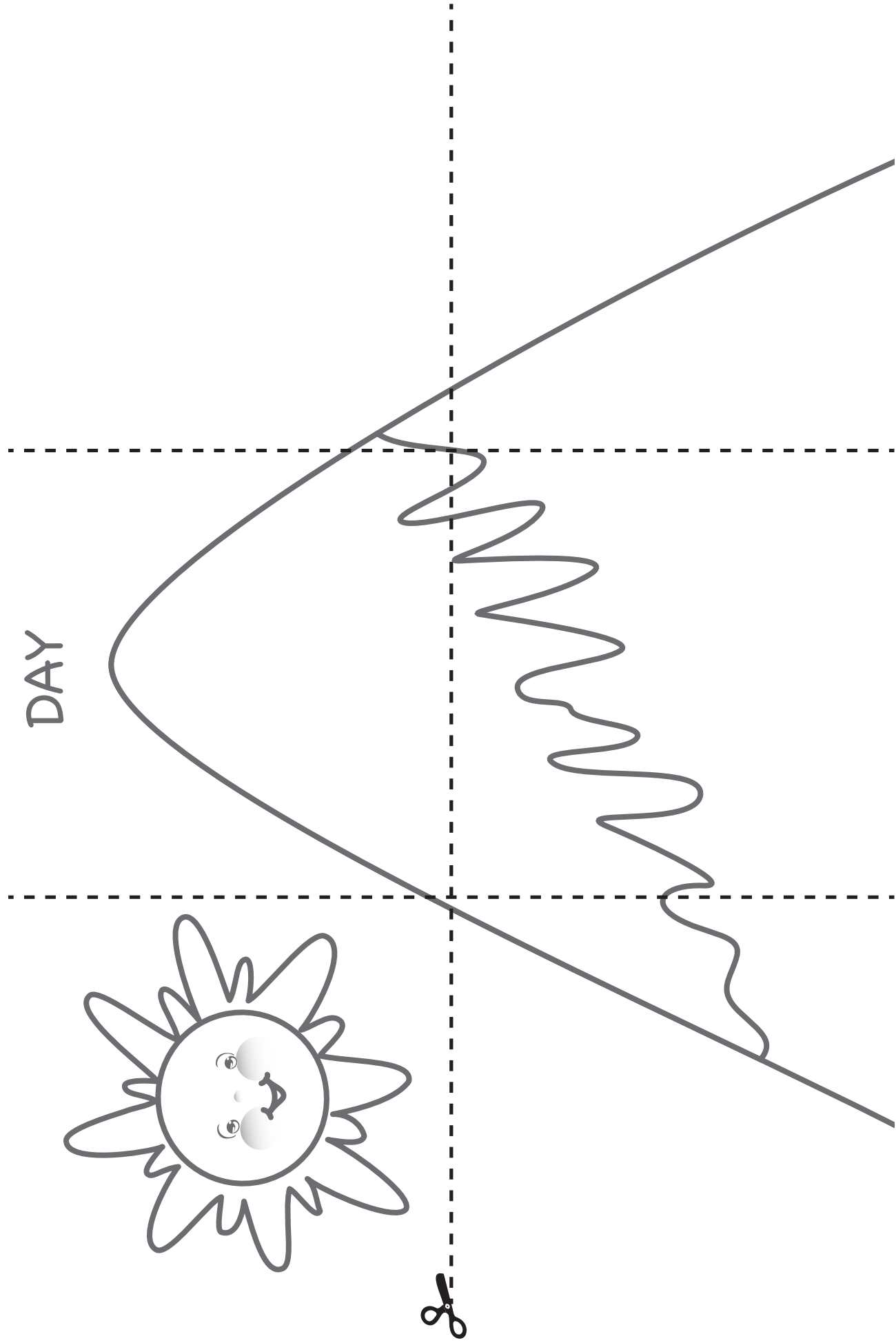

DAY



NIGHT

MOUNTAIN



BEACH

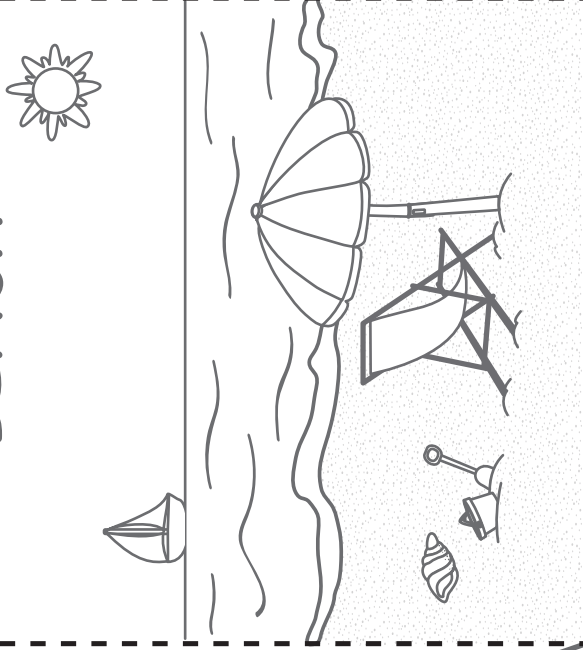

VALLEY

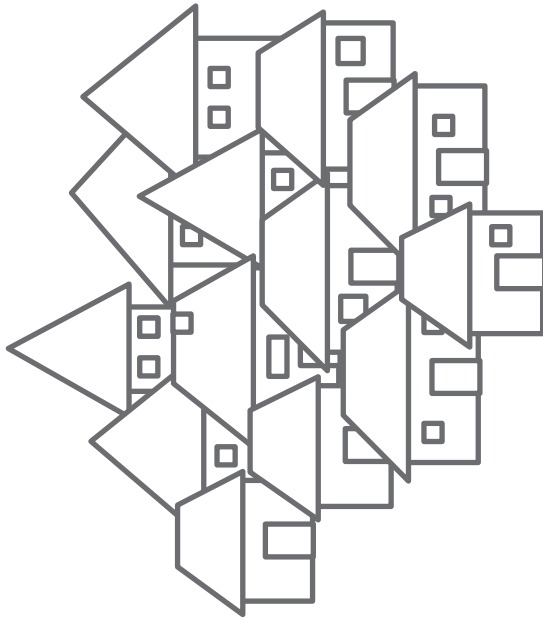
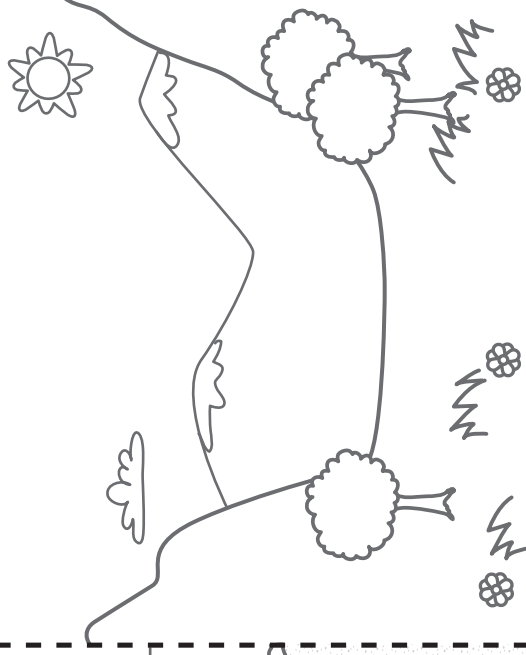

TOWN



RIVER

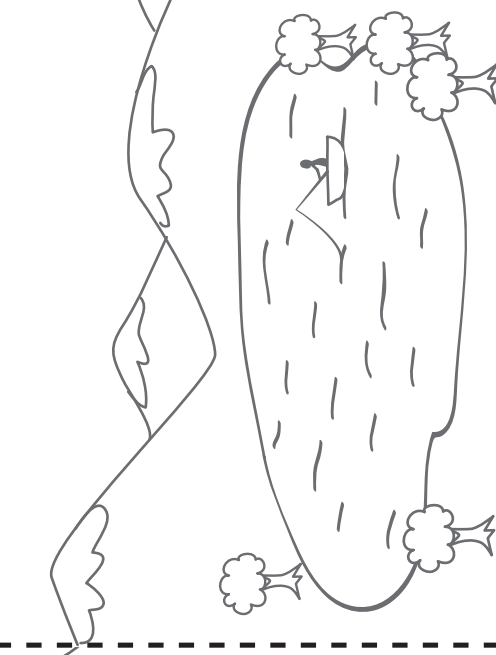

LAKE

SHEEP

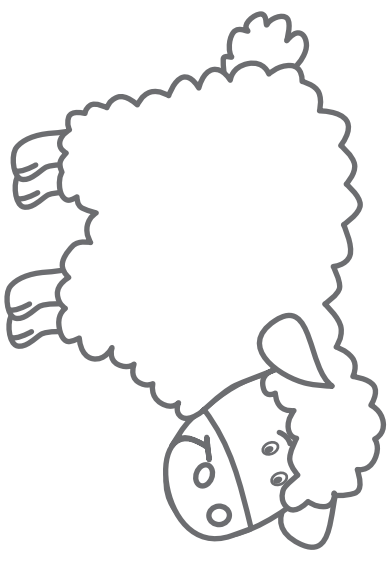

COW



MILK

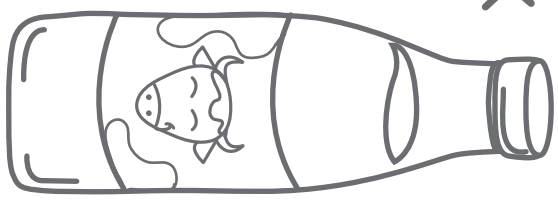

CHEESE

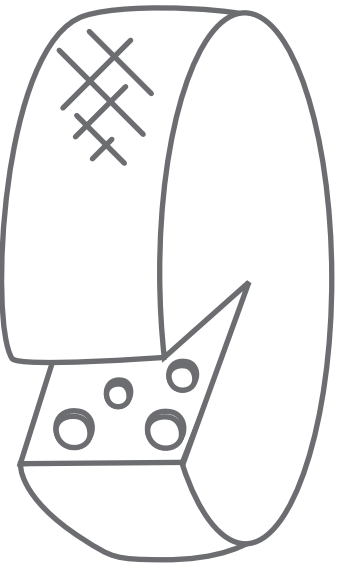

BEAR

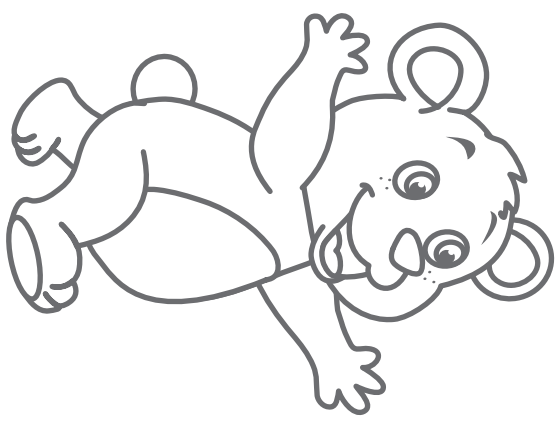

EAGLE

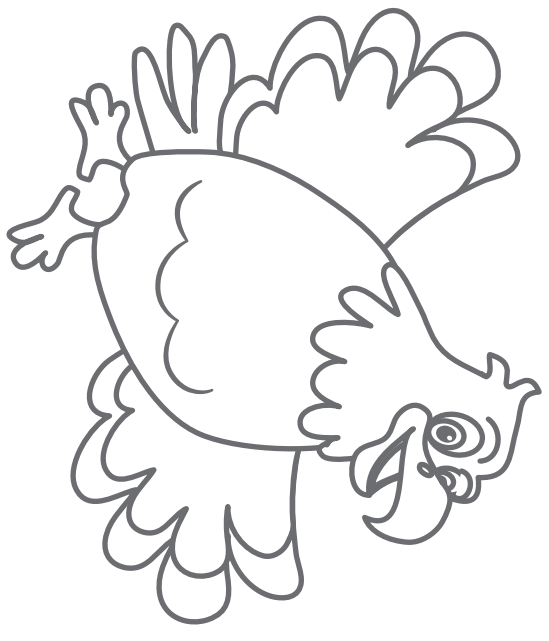

OWL



PENGUIN

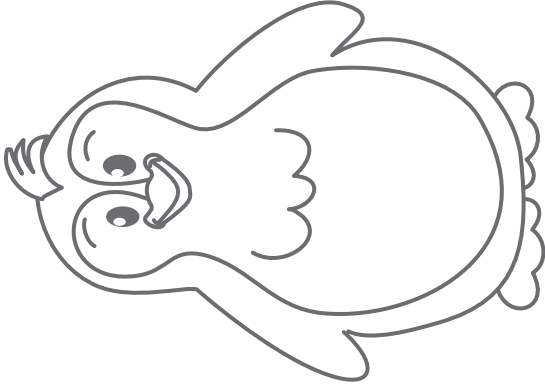

DUCK

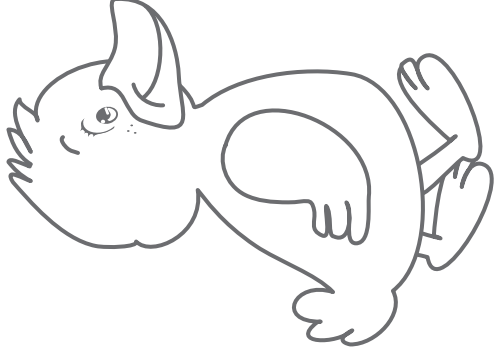

SNAIL

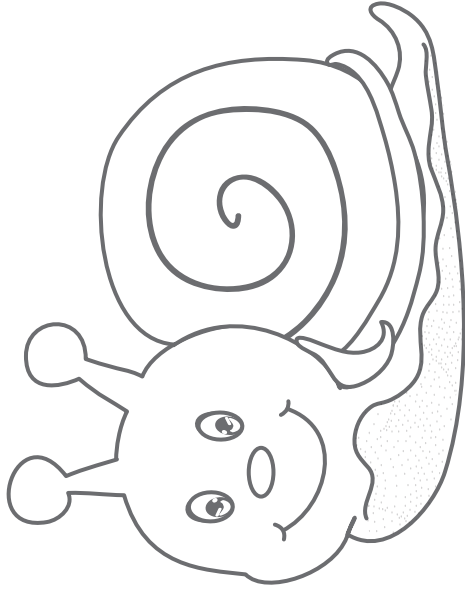

SNAKE

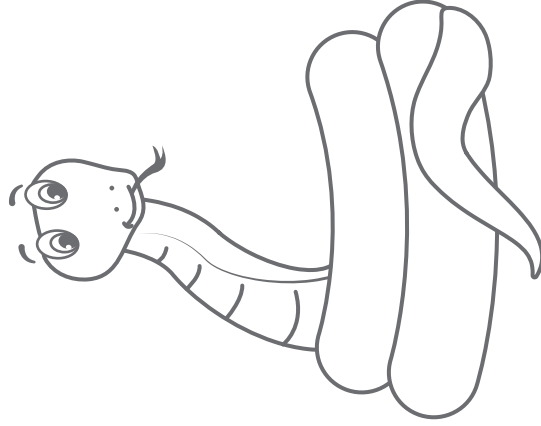

FOX



SKI

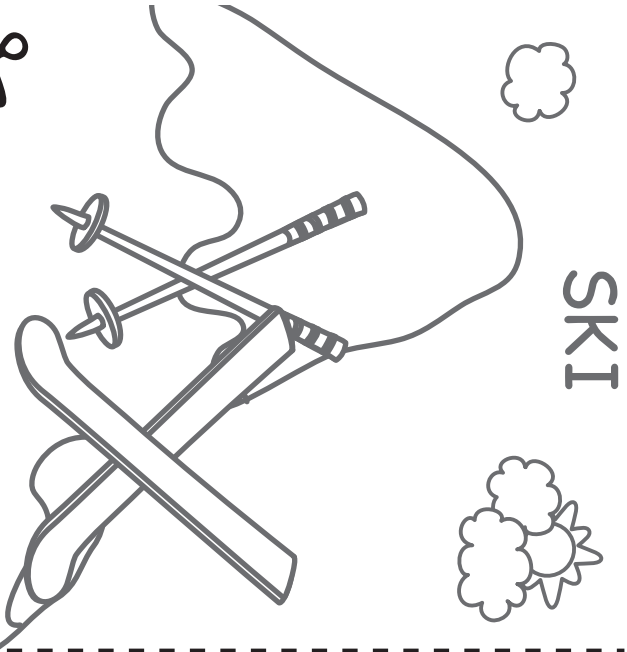

CLIMB

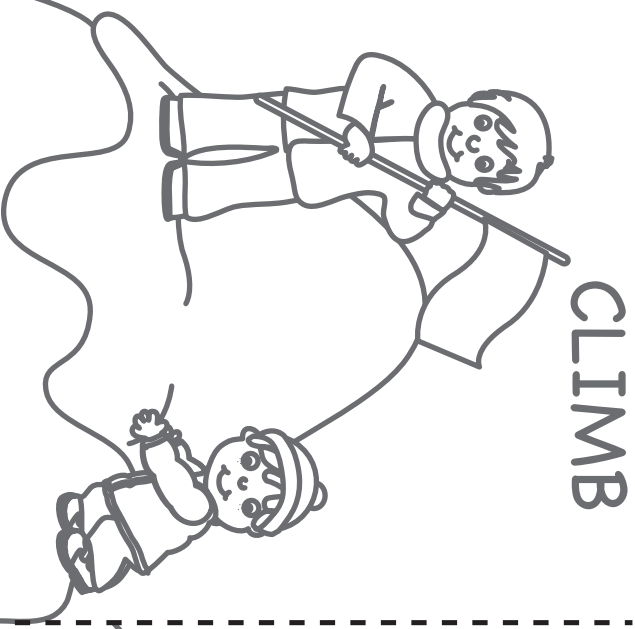

RIDE



WALK



SLEDGE

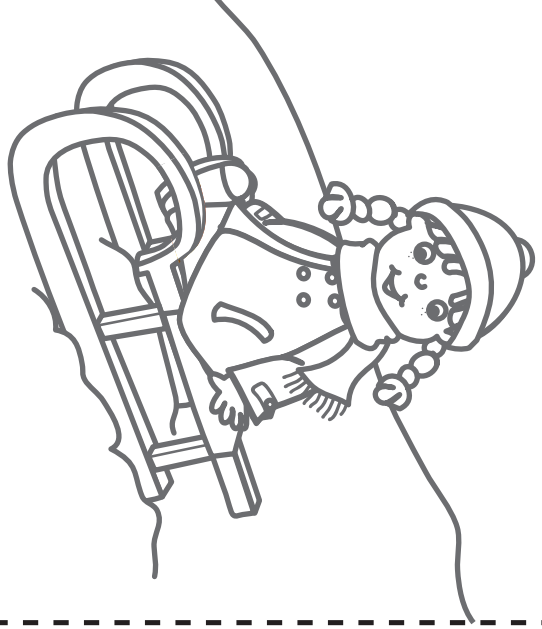

PLAY

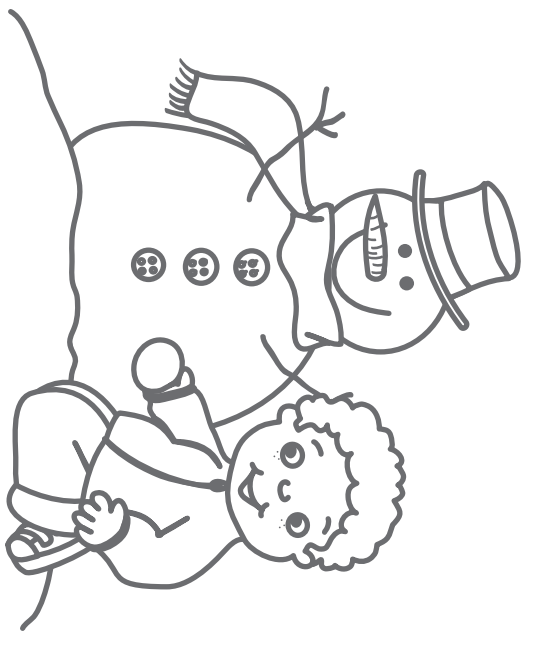

# HAPPY HOLIDAYS!

